

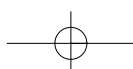

GENERAL INSTRUMENTS

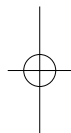
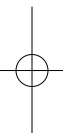
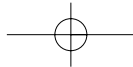

INHALTSVERZEICHNIS

SCHEREN
SCISSORS



5

PINZETTEN
FORCEPS



59

KLEMMEN
FORCEPS



85

NADELHALTER
NEEDLE HOLDER



127

WUNDHAKEN
RETRACTORS



147

ZANGEN
RONGEURS

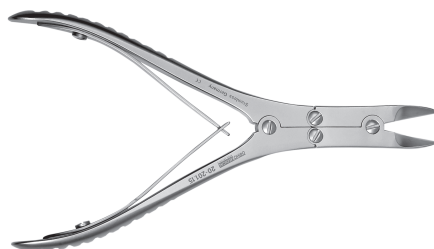

207

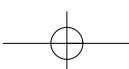
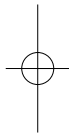
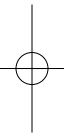
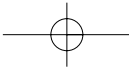



**SCHEREN
SCISSORS**

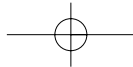

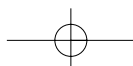
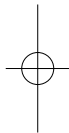
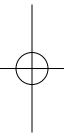

**SCHEREN
SCISSORS**





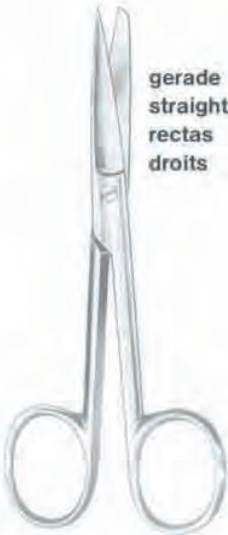

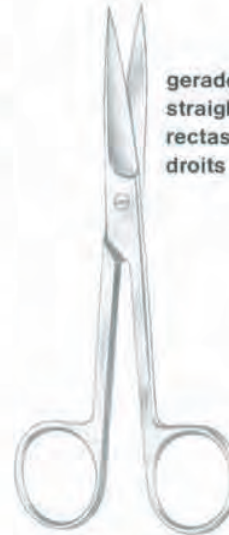
**SCHEREN
SCISSORS**

**Chirurgische Scheren – Operating Scissors
Tijeras para cirugía – Ciseaux à chirurgie**

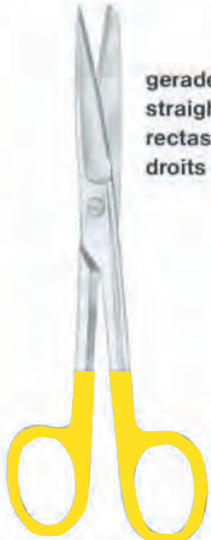
			
gerade straight rectas droits	gerade straight rectas droits	gerade straight rectas droits	gerade straight rectas droits
Standard Fig. 1	Standard Fig. 2	Standard Fig. 3	
01-000.14 14,5 cm / 5½"	10,5 cm / 4" 11,5 cm / 4½" 13 cm / 5" 14,5 cm / 5½" 15,5 cm / 6" 16,5 cm / 6½" 17,5 cm / 7" 18,5 cm / 7¼" 20 cm / 8"	01-001.10 01-001.11 01-001.13 01-001.14 01-001.15 01-001.16 01-001.17 01-001.18 01-001.20	01-002.10 01-002.11 01-002.13 01-002.14 01-002.15 01-002.16 01-002.17 01-002.18 01-002.20
mit extra grossen Ringen with extra large rings con anillos especialmente grandes avec grandes anneaux			01-003.10 01-003.11 01-003.13 01-003.14 01-003.15 01-003.16 01-003.17 01-003.18 01-003.20

TC

			
gerade straight rectas droits			
Standard TC 14,5 cm / 5½"	Fig. 1 02-001.14	Fig. 2 02-002.14	Fig. 3 02-003.14

**SCHEREN
SCISSORS**

**Chirurgische Scheren – Operating Scissors
Tijeras para cirugia – Ciseaux à chirurgie**



	Standard Fig. 1		Standard Fig. 2		Standard Fig. 3	
01-006.14	10,5 cm / 4"	01-007.10	01-008.10	01-009.10		
14,5 cm / 5½"	11,5 cm / 4½"	01-007.11	01-008.11	01-009.11		
	13 cm / 5"	01-007.13	01-008.13	01-009.13		
mit extra grossen Ringen	14,5 cm / 5½"	01-007.14	01-008.14	01-009.14		
with extra large rings	15,5 cm / 6"	01-007.15	01-008.15	01-009.15		
con anillos especialmente	16,5 cm / 6½"	01-007.16	01-008.16	01-009.16		
grandes	17,5 cm / 7"	01-007.17	01-008.17	01-009.17		
avec grandes anneaux	18,5 cm / 7½"	01-007.18	01-008.18	01-009.18		
	20 cm / 8"	01-007.20	01-008.20	01-009.20		

TC

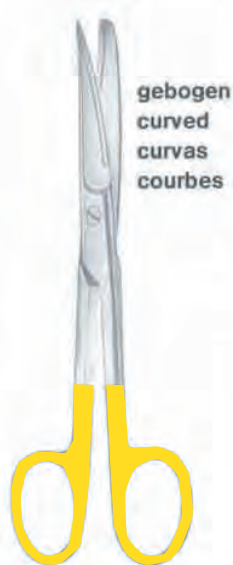

Standard TC
14,5 cm / 5½"



Fig. 1
02-006.14



Fig. 2
02-007.14



Fig. 3
02-008.14

**SCHEREN
 SCISSORS**
**Chirurgische Scheren – Operating Scissors
 Tijeras para cirugia – Ciseaux à chirurgie**
**Standard
 Grazil**

 gerade
 straight
 rectas
 droits

 13 cm / 5"
 14,5 cm / 5½"

 Fig. 1
 01-012.13
 01-012.14

 Fig. 2
 01-013.13
 01-013.14

 Fig. 3
 01-014.13
 01-014.14

**Standard
 Grazil**

 gebogen
 curved
 curvas
 courbes

 13 cm / 5"
 14,5 cm / 5½"

 Fig. 1
 01-015.13
 01-015.14

 Fig. 2
 01-016.13
 01-016.14

 Fig. 3
 01-017.13
 01-017.14

**SCHEREN
SCISSORS**

**Chirurgische Scheren – Operating Scissors
Tijeras para cirugia – Ciseaux à chirurgie**



Deaver
14,5 cm / 5½"

01-018.14
gerade – straight
rectas – droits



01-019.14
gebogen – curved
curvas – courbes



Mixer
15,5 cm / 6"

01-020.15
gerade – straight
rectas – droits



01-021.15
gebogen – curved
curvas – courbes



Lexer
16 cm / 6¼"

01-022.16
gerade – straight
rectas – droits



01-023.16
gebogen – curved
curvas – courbes



02-011.16
gerade – straight
rectas – droits



02-012.16
gebogen – curved
curvas – courbes

**SCHEREN
SCISSORS**

**Chirurgische Scheren – Operating Scissors
Tijeras para cirugia – Ciseaux à chirurgie**

Inzisionsscheren
Incision Scissors
Tijeras para incision
Ciseaux à incision



13 cm / 5" 01-026.13
14,5 cm / 5½" 01-026.14
16,5 cm / 6½" 01-026.16



Richter
01-028.14
14,5 cm / 5½"



Richter
01-029.14
14,5 cm / 5½"



Fergusson
01-030.18
18 cm / 7"



New Suture
01-031.14
14,5 cm / 5½"

**SCHEREN
SCISSORS**

**Chirurgische und gynäkologische Scheren – Operating and gynecological Scissors
Tijeras para cirugía y ginecología – Ciseaux à chirurgie et à ginecologie**

Mayo



Mayo		Mayo TC	
gerade – straight rectas – droits	gebogen – curved curvas – courbes	gerade – straight rectas – droits	gebogen – curved curvas – courbes
14,5 cm / 5½"	01-035.14	02-015.14	02-016.14
15 cm / 6"	01-035.15	02-015.17	02-016.17
17 cm / 6¾"	01-035.17	02-015.23	02-016.23
23 cm / 9"	01-035.23		
28 cm / 11"	01-035.28		

Mayo-Stille



Mayo-Stille		Mayo-Stille TC	
gerade – straight rectas – droits	gebogen – curved curvas – courbes	gerade – straight rectas – droits	gebogen – curved curvas – courbes
15 cm / 6"	01-037.15	02-017.15	02-018.15
17 cm / 6¾"	01-037.17	02-017.17	02-018.17
19,5 cm / 7¾"	01-037.19		
21 cm / 8¼"	01-038.21		

**SCHEREN
SCISSORS**

**Chirurgische Scheren, Präparierscheren – Operating and Preparation Scissors
Tijeras para cirugía y preparaciones – Ciseaux à chirurgie et à préparations**



**SCHEREN
SCISSORS**

**Präparierscheren – Dissecting Scissors
Tijeras para preparaciones – Ciseaux à dissection**

Metzenbaum

gerade
straight
rectas
droits



Fig. 1
01-051.14
14,5 cm / 5½"

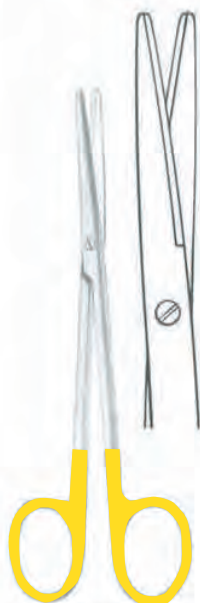

Fig. 2
01-052.14
14,5 cm / 5½"



Fig. 3
01-053.14
14,5 cm / 5½"

TC



Metzenbaum TC
02-021.14
14,5 cm / 5½"

TC

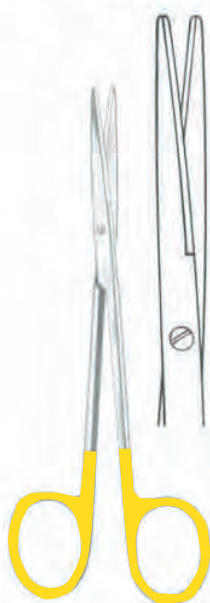

Metzenbaum-Fino TC
02-022.14
14,5 cm / 5½"

TC



Metzenbaum-Fino TC
02-023.14
14,5 cm / 5½"

**SCHEREN
SCISSORS**

**Präparierscheren – Dissecting Scissors
Tijeras para preparaciones – Ciseaux à dissection**

Metzenbaum

gebogen
curved
curvas
courbes



Fig. 1
01-054.14
14,5 cm / 5½"



Fig. 2
01-055.14
14,5 cm / 5½"



Fig. 3
01-056.14
14,5 cm / 5½"

TC

TC

TC

gebogen
curved
curvas
courbes

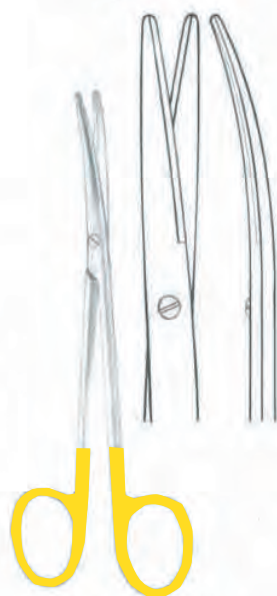

Metzenbaum TC
02-026.14
14,5 cm / 5½"



Metzenbaum-Fino TC
02-027.14
14,5 cm / 5½"

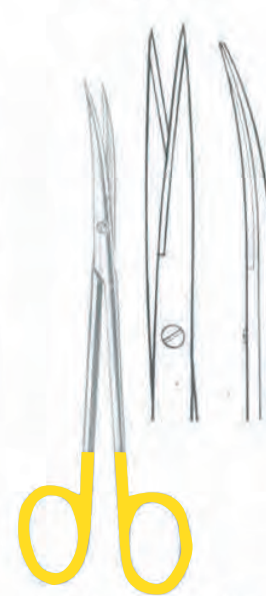

Metzenbaum-Fino TC
02-028.14
14,5 cm / 5½"

**SCHEREN
SCISSORS**

**Präparierscheren – Dissecting Scissors
Tijeras para preparaciones – Ciseaux à dissection**



Metzenbaum-Fino		Metzenbaum	
gerade – straight – rectas – droits		gerade – straight – rectas – droits	
18 cm / 7"	01-057.18	01-058.18	01-059.18
20 cm / 8"	01-057.20	01-058.20	01-059.20
23 cm / 9"	01-057.23	01-058.23	01-059.23
25 cm / 10"	01-057.25	01-058.25	01-059.25
28 cm / 11"	01-057.28	01-058.28	01-059.28
30 cm / 12"		01-058.30	01-059.30

TC

TC

TC

gerade
straight
rectas
droits

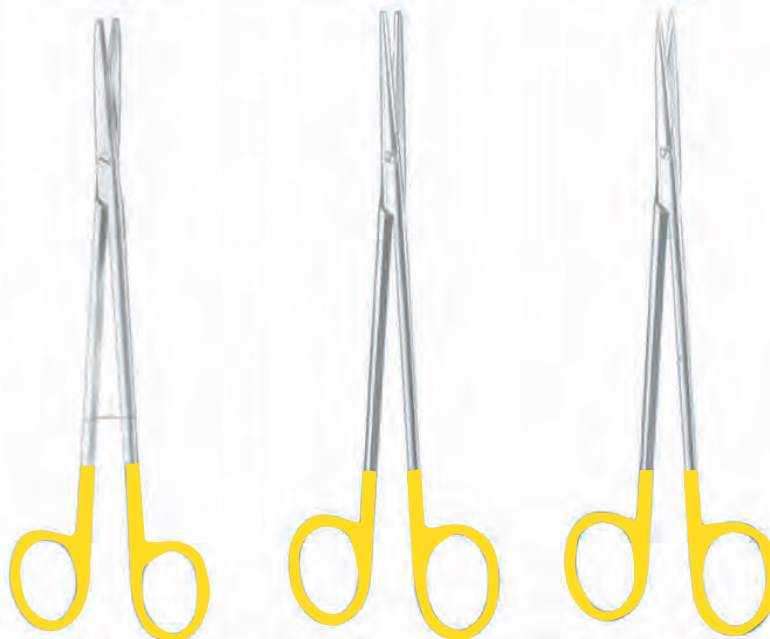

	Metzenbaum TC	Metzenbaum-Fino TC	Metzenbaum-Fino TC
18 cm / 7"	02-031.18	02-032.18	02-033.18
20 cm / 8"	02-031.20	02-032.20	02-033.20
23 cm / 9"	02-031.23	02-032.23	02-033.23
25 cm / 10"	02-031.25	02-032.25	
28 cm / 11"	02-031.28	02-032.28	

**SCHEREN
SCISSORS**

**Präparierscheren – Dissecting Scissors
Tijeras para preparaciones – Ciseaux à dissection**



Metzenbaum-Fino		Metzenbaum	
gebogen – curved – curvas – courbes		gebogen – curved – curvas – courbes	
18 cm / 7"	01-063.18	01-064.18	01-065.18
20 cm / 8"	01-063.20	01-064.20	01-065.20
23 cm / 9"	01-063.23	01-064.23	01-065.23
25 cm / 10"	01-063.25	01-064.25	01-065.25
28 cm / 11"	01-063.28	01-064.28	01-065.28
30 cm / 12"	01-063.30	01-064.30	01-065.30

TC

TC

TC

gebogen
curved
curvas
courbes

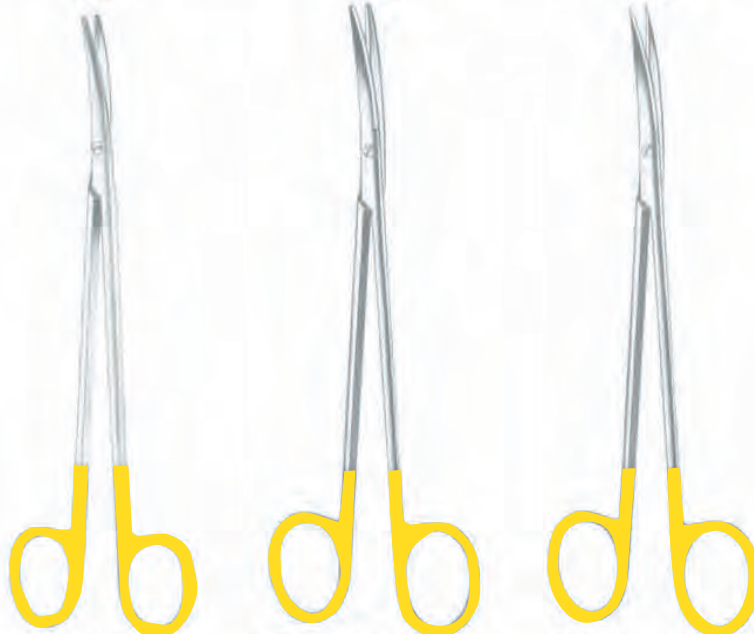

	Metzenbaum TC	Metzenbaum-Fino TC	Metzenbaum-Fino TC
18 cm / 7"	02-036.18	02-037.18	02-038.18
20 cm / 8"	02-036.20	02-037.20	02-038.20
23 cm / 9"	02-036.23	02-037.23	02-038.23
25 cm / 10"	02-036.25	02-037.25	
28 cm / 11"	02-036.28	02-037.28	

**SCHEREN
SCISSORS**

**Gynäkologische Scheren – Gynecological Scissors
Tijeras para ginecologia – Ciseaux à gynécologie**

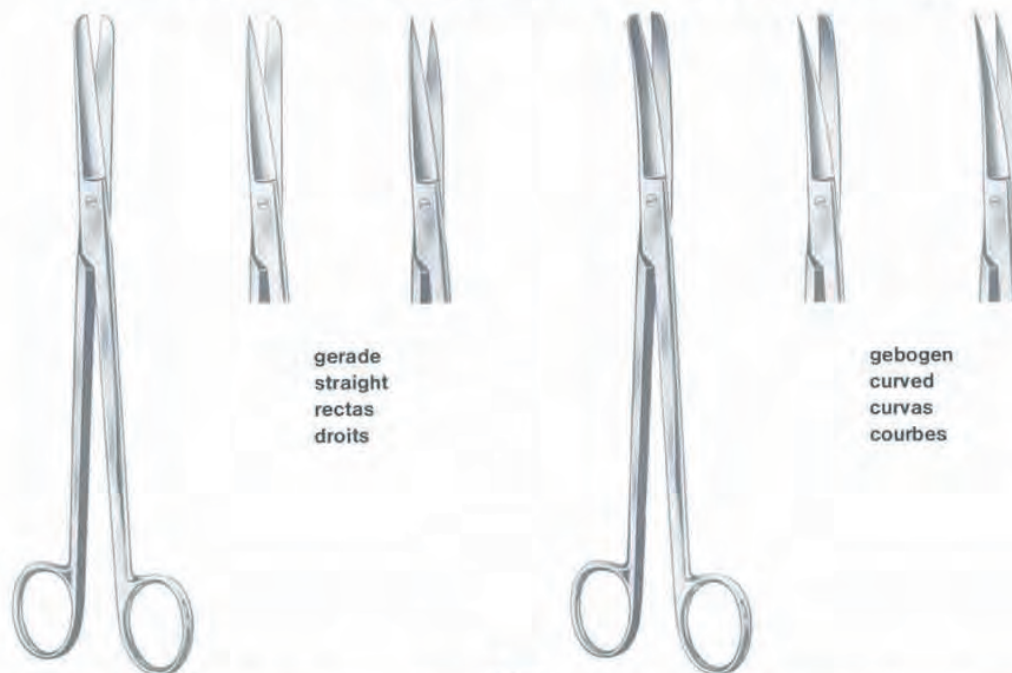

gerade
straight
rectas
droits

gebogen
curved
curvas
courbes

Sims

20 cm / 8"	01-069.20	01-070.20	01-071.20	01-072.20	01-073.20	01-074.20
23 cm / 9"	01-069.23	01-070.23	01-071.23	01-072.23	01-073.23	01-074.23

**Kephalotom-Scheren
Cephalotomy-Scissors
Tijeras para decapitacion
Ciseaux à détroncation
27 cm / 10 1/4"**



Werheim

14,5 cm / 5 3/4"	01-075.14
19,5 cm / 7 3/4"	01-075.19
22,5 cm / 9"	01-075.22

**Dubois
27 cm / 10 1/2"**

gerade
straight
rectas
droits
01-076.27

gebogen
curved
curvas
courbes
01-077.27

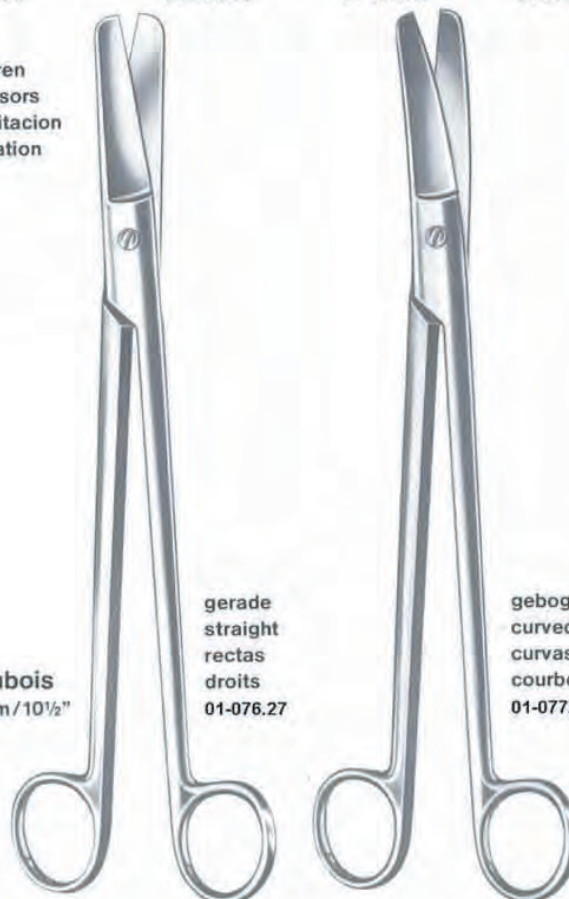

**SCHEREN
 SCISSORS**
**Bauchdecken- und gynäkologische Scheren – Abdominal and Gynecological Scissors
 Tijeras abdominales y para ginecología – ciseaux abdominaux et à gynécologie**

Doyen
 16 cm / 6 1/4"
 01-080.16



Doyen
 16 cm / 6 1/4"
 01-081.16



01-082.16



Doyen
 17,5 cm / 7"
 01-081.18



01-082.18

Fistelscheren
 Fistula Scissors
 Tijeras para fistulas
 Ciseaux pour fistules



16 cm / 6 1/4"
 18 cm / 7"

Kelly
 01-083.16
 01-083.18



01-084.16
 01-084.18



Vezién
 01-085.16
 18 cm / 7"



Siebold
 01-086.24
 24 cm / 9 1/2"

**SCHEREN
SCISSORS**

**Feine chirurgische Scheren – Fine Operating Scissors
Tijeras finas para cirugia – Ciseaux fins à chirurgie**



Fig. 1
01-087.12



Fig. 2
01-088.12



Fig. 3
01-089.12

gerade
straight
rectas
droits
12 cm / 4 3/4"



Fig. 1
01-090.12



Fig. 2
01-091.12



Fig. 3
01-092.12

gebogen
curved
curvas
courbes
12 cm / 4 3/4"



gerade – straight
rectas – droits
01-093.11
11 cm / 4 1/4"



gebogen – curved
curvas – courbes
01-094.11
11 cm / 4 1/4"

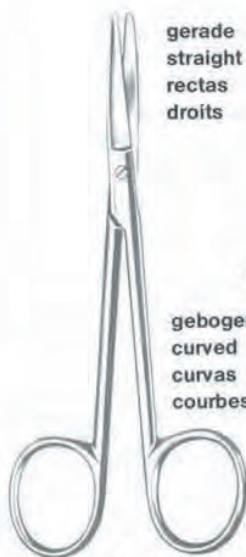

Wagner
12 cm / 4 3/4"

gerade
straight
rectas
droits



Fig. 1
01-095.12



Fig. 2
01-096.12



Fig. 3
01-097.12

gebogen
curved
curvas
courbes



Fig. 1
01-098.12



Fig. 2
01-099.12



Fig. 3
01-100.12

**SCHEREN
SCISSORS**

**Feine chirurgische Scheren – Fine Operating Scissors
Tijeras finas para cirugia – Ciseaux fins chirurgiaux**



gerade – straight
rectas – droits
01-103.11
11,5 cm / 4½"

gebogen – curved
curvas – courbes
01-104.11
11,5 cm / 4½"

gerade – straight
rectas – droits
01-105.11
11,5 cm / 4½"

gebogen – curved
curvas – courbes
01-106.11
11,5 cm / 4½"

Brophy (Sullivan)
gerade – straight
rectas – droits
01-107.14
14,5 cm / 5½"

gebogen – curved
curvas – courbes
01-108.14
14,5 cm / 5½"



Reynolds
Gerade – straight
Rectas – droits
15 cm / 6" 01-109.15
18 cm / 7" 01-109.18

Gebogen – curved
Curvas – courbes
01-110.15
01-110.18

01-111.12

01-112.12

01-113.12

01-114.12

Landolt
12,5 cm / 5"

**SCHEREN
SCISSORS**

**Feine Scheren – Fine Scissors
Tijeras finas – Ciseaux fins**



				Standard	
9 cm / 3½"				01-118.09	01-119.09
10,5 cm / 4 1/8"	01-115.10	01-116.10		01-118.10	01-119.10
11,5 cm / 4 ½"	01-115.11	01-116.11	01-117.11	01-118.11	01-119.11



01-120.09
9 cm / 3½"

gerade – straight
rectas – droits
01-121.14
14,5 cm / 5½"

Sanvenero

gebogen – curved
curvas – courbes
01-122.14
14,5 cm / 5½"

Walton
01-123.10
10 cm / 4"

**SCHEREN
SCISSORS**

**Feine Scheren – Fine Scissors
Tijeras finas – Ciseaux fins**



Baby-Lexer
gerade – straight
rectas – droits
01-124.10
10 cm / 4"



gebogen – curved
curvas – courbes
01-125.10
10 cm / 4"



gerade – straight
rectas – droits
01.126.13
13 cm / 5"

gebogen – curved
curvas – courbes
01-127.13
13 cm / 5"

**Scheren für plastische Operationen – Plastic Surgery Scissors
Tijeras para operaciones plásticas – Ciseaux pour opérations plastiques**



gerade – straight
rectas – droits

01-130.14
14 cm / 5½"



gebogen – curved
curvas – courbes

01-131.14
14 cm / 5½"



Kilner

12 cm / 4¾" 01-132.12
15 cm / 6" 01-132.15

**SCHEREN
SCISSORS**

**Gefäßscheren – Vascular Scissors
Tijeras vasculares – Ciseaux vasculaires**



01-133.14
14,5 cm / 5½"

Coronar-Schere
Coronary-Scissors
Tijera coronaria
Ciseaux coronaires



01-135.11
11,5 cm / 4 ½"



Potts-Smith
01-136.19
19,5 cm / 7¾"



De Bakey
01-137.15
15,5 cm / 6"



De Bakey
01-138.15
15,5 cm / 6"



Favaloro
01-139.15
15 cm / 6"

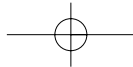

**SCHEREN
SCISSORS**

**Scheren für Gefäss-Chirurgie – Scissors for Vascular-Surgery
Tijeras para cirugía vasculares – Ciseaux pour chirurgie vasculaires**

TC

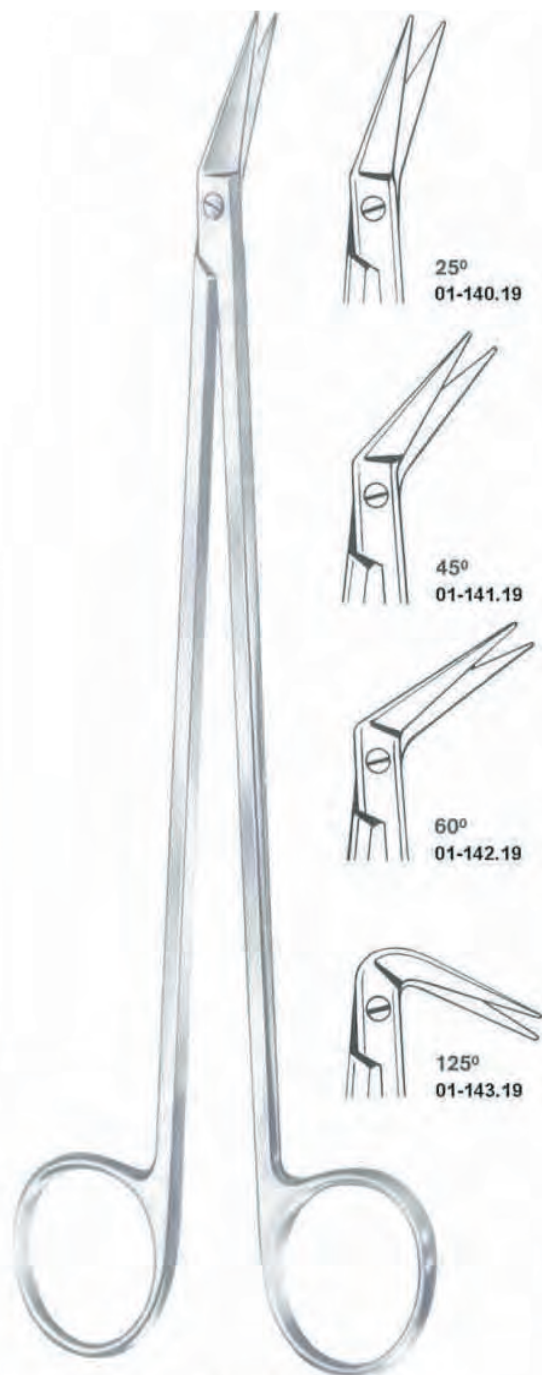

Potts-Smith
19 cm / 7½"

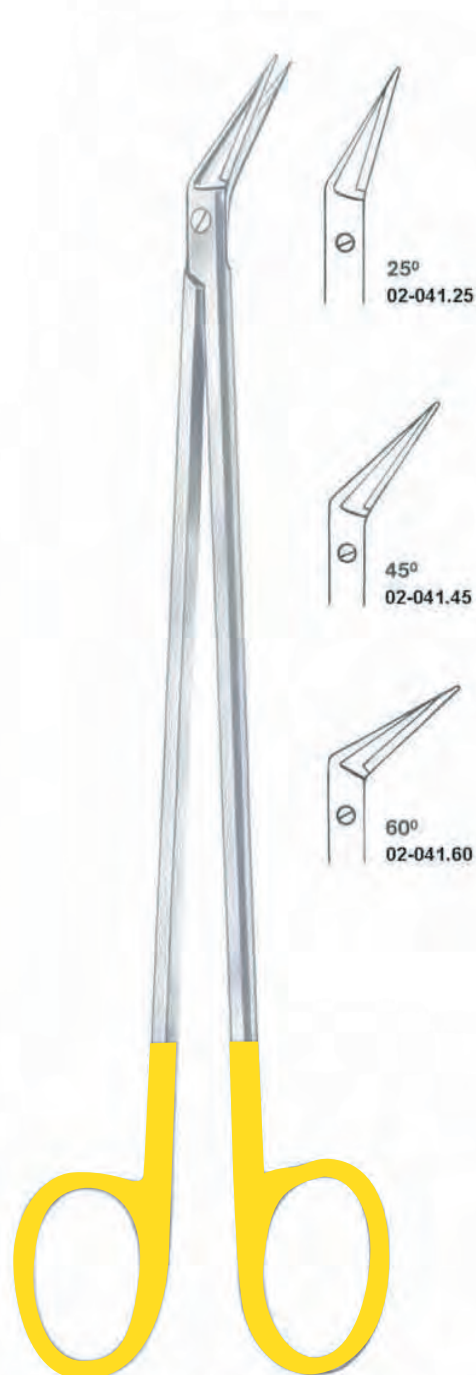

Potts-Smith TC
19 cm / 7½"

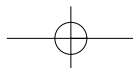

**SCHEREN
SCISSORS**

**Knorpelschere – Cartilage Scissors
Tijeras para cartilago – Ciseaux pour le cartilage**



gezahnt – saw edge
dentadas – dentelés

Martin-Cartilage
01-144.19
20 cm / 8"



Mc Indoe
01-145.19
19 cm / 7½"



Potts-Smith
01-146.19
19 cm / 7½"



Gefäßscheren
Vascular Scissors
Tijeras vasculares
Ciseaux vasculaires

Satinsky
01-147.24
24,5 cm / 10"



Klingenberg-Loth
01-148.23
23 cm / 9"

**SCHEREN
SCISSORS**

**Gefäßscheren – Vascular Scissors
Tijeras vasculares – Ciseaux vasculaires**

TC

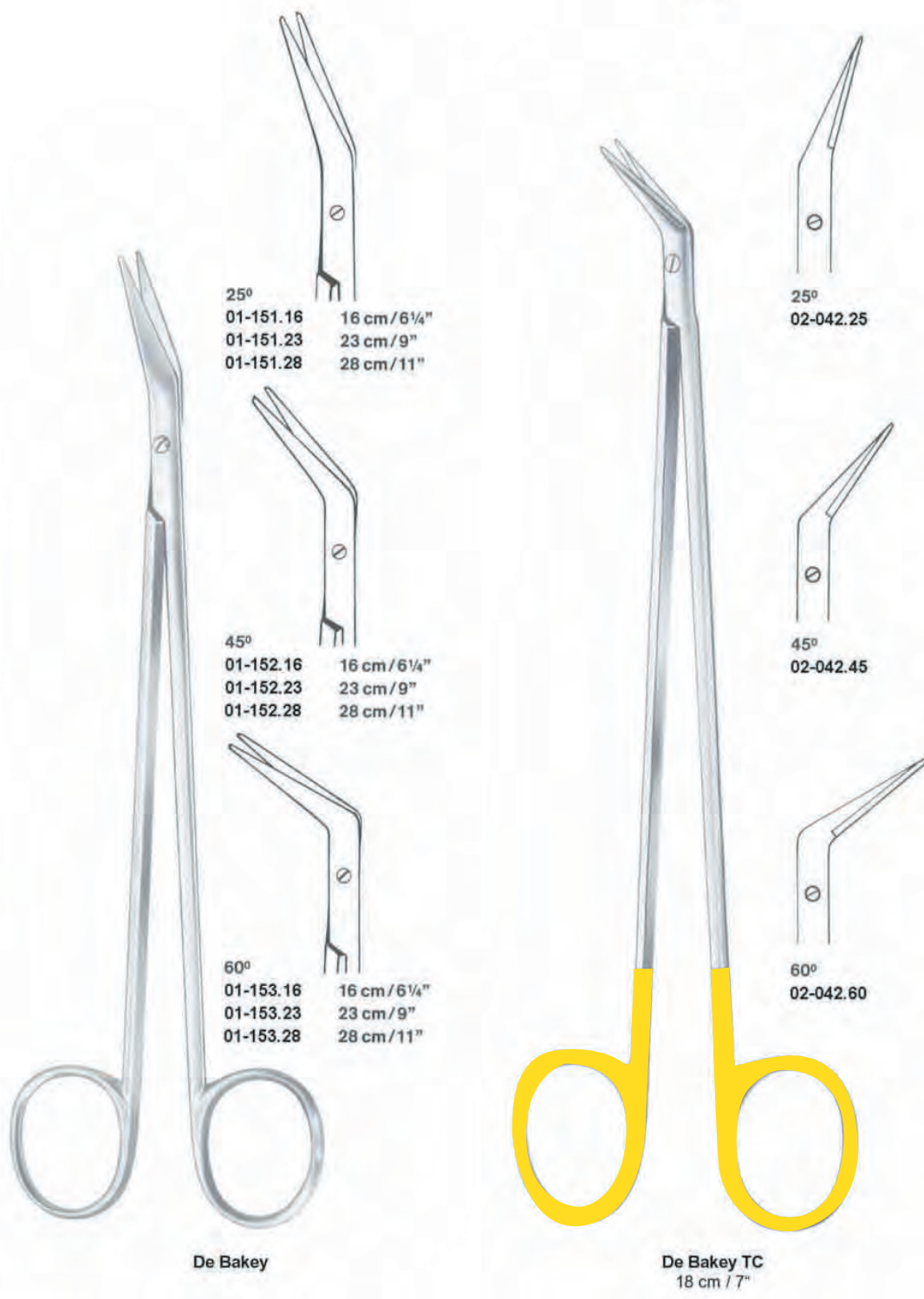

**SCHEREN
SCISSORS**

**Scheren für Gefäß-Chirurgie – Scissors for Vascular-Surgery
Tijeras para cirugía vasculares – Ciseaux pour chirurgie vasculaires**

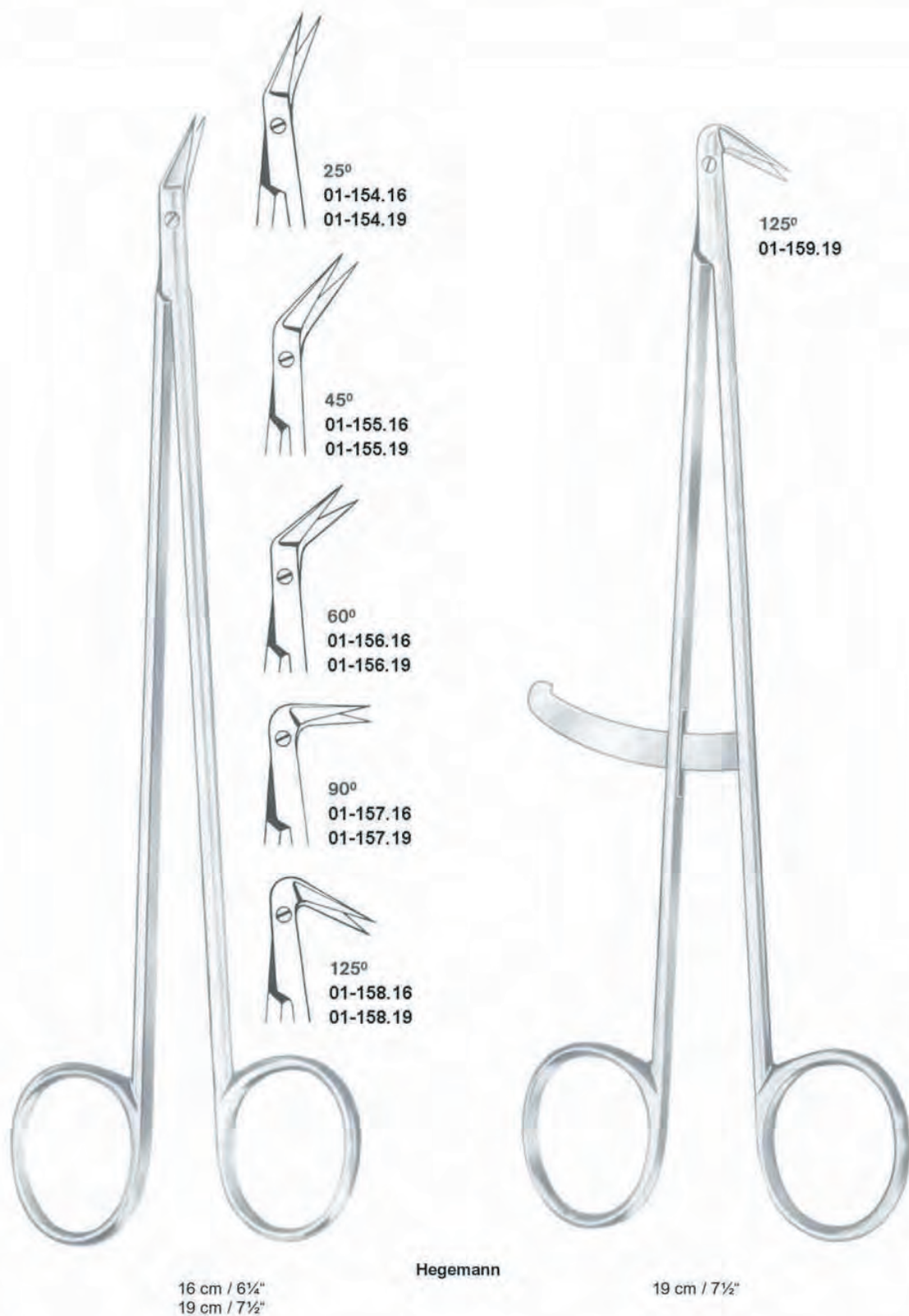

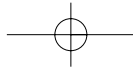

**SCHEREN
SCISSORS**

**Gefäßscheren – Vascular Scissors
Tijeras vasculares – Ciseaux vasculaires**

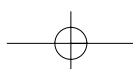
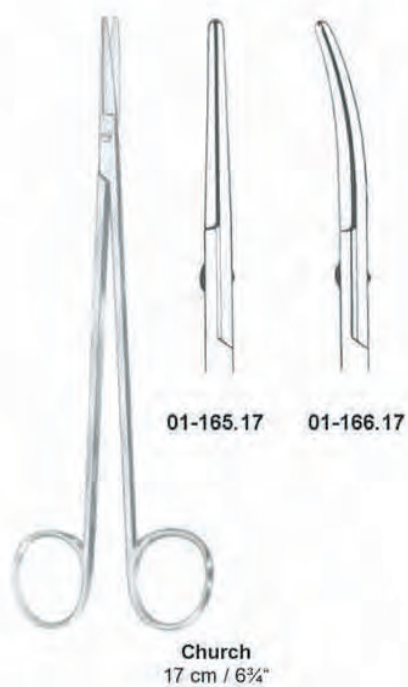

**SCHEREN
SCISSORS**

Nerv-Präparierschere
Nerve dissecting Scissors
Tijeras para nervios
Ciseaux pour nerfs



01-068.15
15 cm / 6"

Tonsillenscheren
Tonsil Scissors
Tijeras para amígdalas
Ciseaux pour les amygdales



Böttcher
01-169.18
18 cm / 7"



Prince
01-170.17
17,5 cm / 7"

TC

Präparierscheren
Preparation Scissors
Tijeras para preparaciones
Ciseaux à dissection



Tönnis
gerade – straight
rectas – droits
01-171.18
18 cm / 7"



gebogen – curved
curvas – courbes
01-172.18
18 cm / 7"



Tönnis-Adson
01-173.17
17,5 cm / 7"



Tönnis-Adson TC
02-045.17
17,5 cm / 7"

**SCHEREN
SCISSORS**

**Tonsillenscheren
Tonsil Scissors
Tijeras para amígdalas
Ciseaux pour les amygdales**



Good
01-174.19
19 cm / 7½"



Good-Schweckendick
01-175.19
19 cm / 7½"

**gezahnt
saw edge
dentadas
dentelés**

**Lungenlappenscheren
Lobectomy Scissors
Tijeras para lobectomía
Ciseaux à lobectomie**



Crafoord
01-176.30
30 cm / 12"



Finochietto
01-177.27
27 cm / 10½"

**Darmscheren – Enterotomy Scissors
Tijeras enterótomos – Ciseaux-entérotomes**



01-178.21
21 cm / 8¼"



01-179.21
21 cm / 8¼"



01-180.21
21 cm / 8¼"

**SCHEREN
SCISSORS**

**Nabelschnurscheren – Umbilical Scissors
Tijeras umbilicales – Ciseaux pour le cordon ombilical**



Busch
13 cm / 5" 01-181.13
16 cm / 6¼" 01-181.16



Schumacher
01-182.16
16 cm / 6¼"



Mod. USA
01-183.10
10,5 cm / 4"

**Damm- (Episiotomie-) Scheren
Tijeras para perineo (para episiotomía)
Perineum (Episiotomy) Scissors
Ciseaux à périnée (à épisiotomie)**



Braun-Stadler
01-186.14
14 cm / 5½"



Braun-Stadler
01-187.21
21 cm / 8¼"



Braun-Stadler
01-188.22
22 cm / 8¾"

**SCHEREN
SCISSORS**



Waldmann
01-190.18
18 cm / 7"

**Nasen-Scheren
Nasal-Scissors
Tijeras nasales
Ciseaux nasaux**



Heymann
01-191.18
18 cm / 7"



Heymann
01-192.19
19,5 cm / 7½"



Knight
01-193.18
18 cm / 7"

**SCHEREN
SCISSORS**

**Nasenscheren – Nasal-Scissors
Tijeras nasales – Ciseaux nasaux**



Fomon
01-194.13
13 cm / 5"



Fomon
01-195.13
13,5 cm / 5¼"



Fomon
01-196.13
13,5 cm / 5¼"





Cottle
01-197.16
16 cm / 6½"





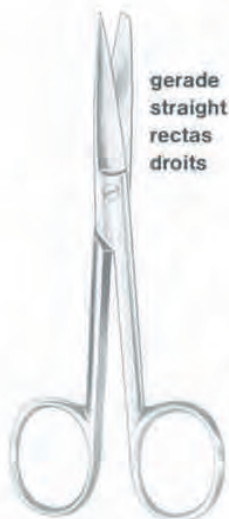

Halle
01-198.19
19 cm / 7½"

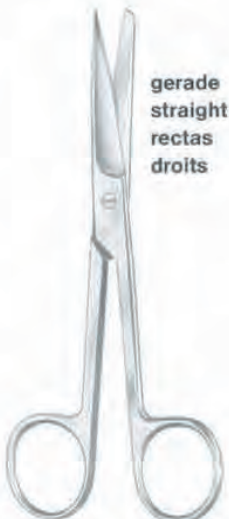
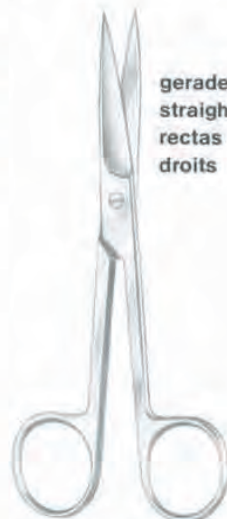
**SCHEREN
SCISSORS**

**Chirurgische Scheren – Operating Scissors
Tijeras para cirugia – Ciseaux à chirurgie**

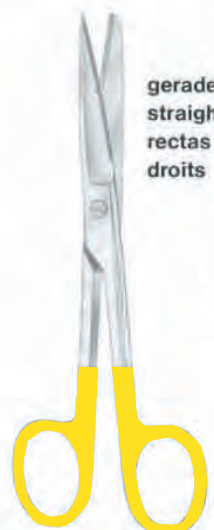
	gerade straight rectas droits		gerade straight rectas droits		gerade straight rectas droits		gerade straight rectas droits
		Standard	Standard	Standard			
		Fig. 1	Fig. 2	Fig. 3			
01-000.14	10,5 cm / 4"	01-001.10	01-002.10	01-003.10			
14,5 cm / 5½"	11,5 cm / 4½"	01-001.11	01-002.11	01-003.11			
	13 cm / 5"	01-001.13	01-002.13	01-003.13			
mit extra grossen Ringen	14,5 cm / 5½"	01-001.14	01-002.14	01-003.14			
with extra large rings	15,5 cm / 6"	01-001.15	01-002.15	01-003.15			
con anillos especialmente	16,5 cm / 6½"	01-001.16	01-002.16	01-003.16			
grandes	17,5 cm / 7"	01-001.17	01-002.17	01-003.17			
avec grandes anneaux	18,5 cm / 7¼"	01-001.18	01-002.18	01-003.18			
	20 cm / 8"	01-001.20	01-002.20	01-003.20			

TC

	gerade straight rectas droits			
Standard TC		Fig. 1	Fig. 2	Fig. 3
14,5 cm / 5½"		02-001.14	02-002.14	02-003.14

**SCHEREN
SCISSORS**

**Mikroscheren, Iridektomiescheren – Micro-, Iris-Scissors
Micro Tijeras, Pinzas-tijeras para iridectomia – Micro-ciseaux, Ciseaux à iridectomie**



Barraquer
5,5 cm / 2¼"

Blätter	5 mm	03-011.05
Cutting blades	7 mm	03-011.07
Hojas cortantes	10 mm	03-011.10
Lames tranchantes		



Westcott
03-012.11
11,5 cm / 4½"



Westcott
03-013.11
11,5 cm / 4½"



03-014.09
9 cm / 3½"



03-015.09



03-016.09



03-017.09



03-018.09

**SCHEREN
SCISSORS**

**Iridektomiescheren, Nachstarscheren – Iridectomy Scissors, Secadary Cataract Scissors
Pinzas Tijeras para iridectomia y para catarata secundaria – Ciseaux à iridectomie,
Ciseaux pour le cataracte secondaire**



gerade
straight
rectas
droits

Vannas
03-019.08
8 cm / 3 1/4"

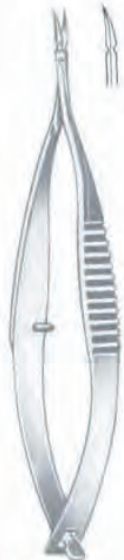

gebogen
curved
curvas
courbes

Vannas
03-020.08
8 cm / 3 1/4"



kniegebogen
angular
acodadas
coudés

Vannas
03-021.08
8 cm / 3 1/4"



aufgewinkelt
angled up
acodadas hacia arriba
coudés vers le haut

Vannas
03-022.08
8 cm / 3 1/4"



gerade
straight
rectas
droits

03-023.08
8,5 cm / 3 1/2"

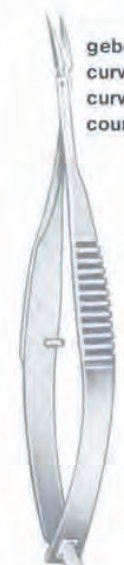

gebogen
curved
curvas
courbes

Vannas Mod. Tübingen
03-024.08
8,5 cm / 3 1/2"



kniegebogen
angular
acodadas
coudés

03-025.08
8,5 cm / 3 1/2"



aufgewinkelt
angled up
aconadas hacia arriba
coudés vers le haut

03-026.08
8,5 cm / 3 1/2"

**SCHEREN
SCISSORS**

**Iridektomiescheren – Iridectomy Scissors
Pinzas, Tijeras para iridectomia – Ciseaux à iridectomie**



03-029.10
10 cm / 4"



03-030.10
10 cm / 4"

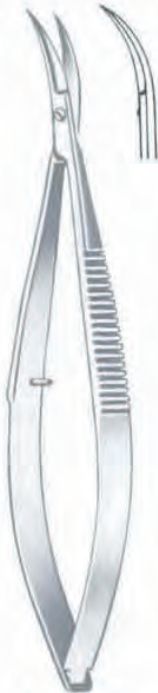

Castroviejo
03-031.10
10 cm / 4"



Castroviejo
03-032.10
10 cm / 4"



Troutman
03-033.10
10 cm / 4"



Troutman
03-034.10
10 cm / 4"



03-035.10
10 cm / 4"



Katzin-Barraquer

03-036.10
10 cm / 4"

**SCHEREN
SCISSORS**

**Iridektomiescheren – Iridectomy Scissors
Pinzas-Tijeras para iridectomia – Ciseaux à iridectomie**

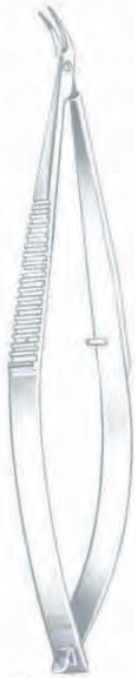

Katzin
03-037.10
10 cm / 4"



Katzin
03-038.10
10 cm / 4"



Westcott
03-039.11
11 cm / 4½"



Westcott
03-040.11
11 cm / 4½"



Castroviejo
03-041.10
10 cm / 4"



Castroviejo
03-042.10
10 cm / 4"

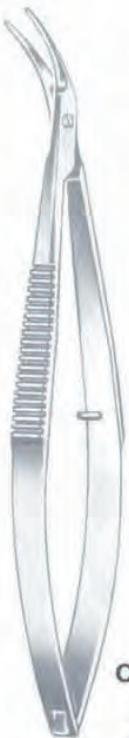

Castroviejo
03-043.11
11 cm / 4½"



Castroviejo
03-044.11
11 cm / 4½"

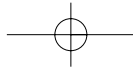

**SCHEREN
SCISSORS**

**Scheren für Gefäß-Chirurgie – Scissors for Vascular-Surgery
Tijeras para cirugía vasculares – Ciseaux pour chirurgie vasculaires**

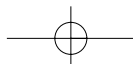
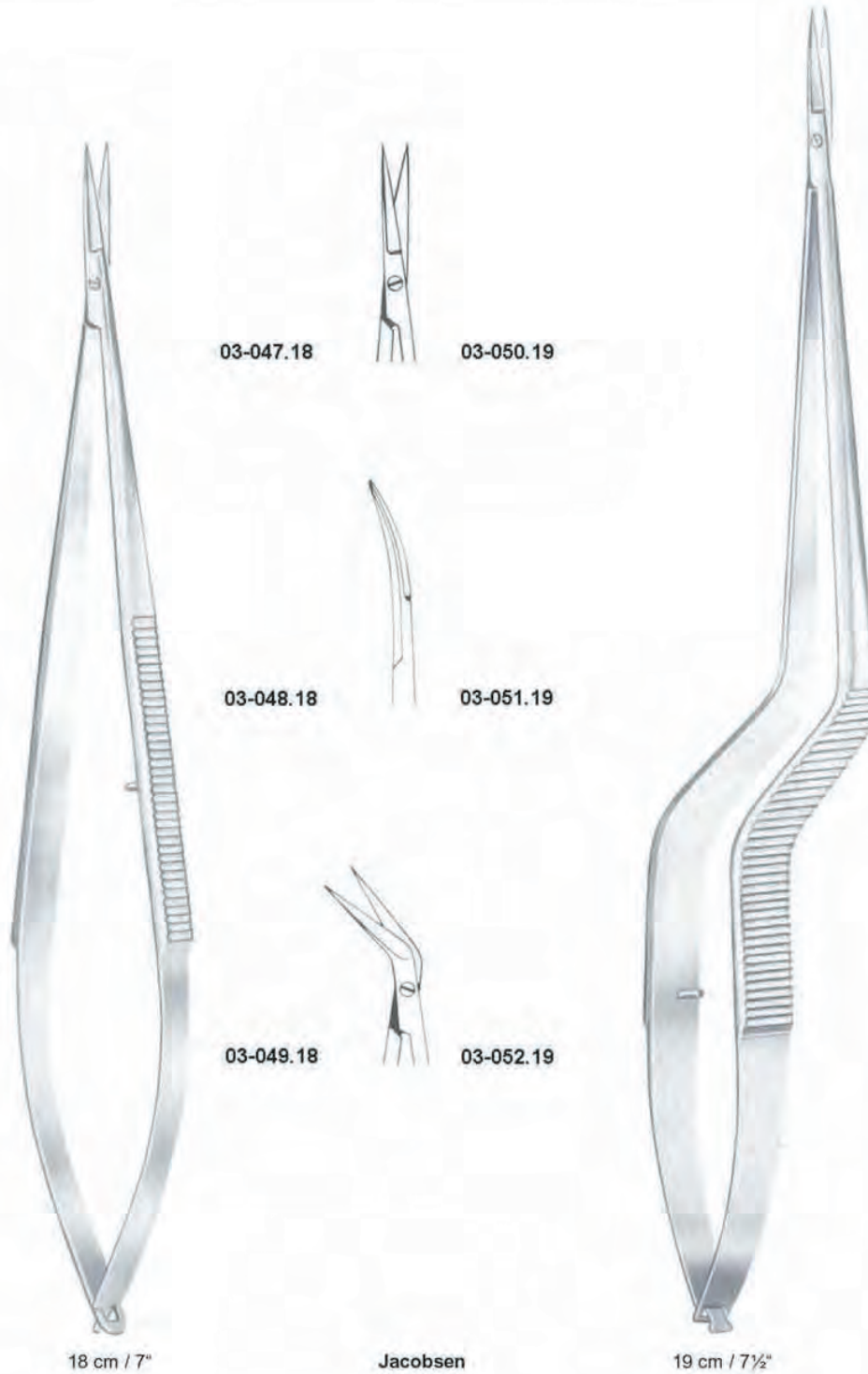

**SCHEREN
SCISSORS**

**Augenscheren, Feine Scheren – Eye Scissors, Fine Scissors
Tijeras oculares, Tijeras finas – Ciseaux oculaires, Ciseaux fins**



01-201.03



01-201.02



01-201.01

gerade
straight
rectas
droites



01-202.03



01-202.02



01-202.01

gebogen
curved
curvas
courbes

TC

TC



gerade – straight
rectas – droites
01-203.12
12 cm / 4¾"



gebogen – curved
curvas – courbes
01-204.12
12 cm / 4¾"



gerade – straight
rectas – droites
02-046.11
11,5 cm / 4½"



gebogen – curved
curvas – courbes
02-047.11
11,5 cm / 4½"

**SCHEREN
SCISSORS**

**Augenscheren – Eye Scissors
Tijeras oculares – Ciseaux oculaires**



Standard					
9 cm / 3½"	01-205.09	01-206.09			
10,5 cm / 4"	01-205.10	01-206.10			
11,5 cm / 4½"	01-205.11	01-206.11	01-207.11	01-208.11	

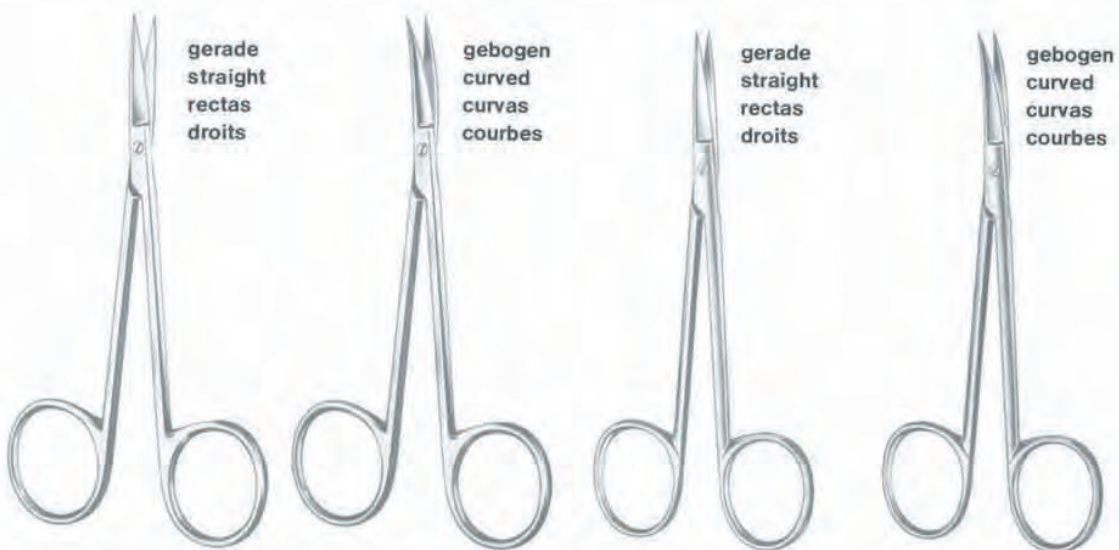

Fino		Fino			
9,5 cm / 3¾"				01-220.09	01-221.09
10,5 cm / 4"	01-209.10	01-210.10		01-220.10	01-221.10
11,5 cm / 4½"	01-209.11	01-210.11		01-220.11	01-221.11

**SCHEREN
SCISSORS**

**Augenscheren – Eye Scissors
Tijeras oculares – Ciseaux oculaires**



Fino
gerade – straight
rectas – droits
9,5 cm / 3¾" 01-224.09
10,5 cm / 4" 01-224.10
11,5 cm / 4½" 01-224.11



Fino
gebogen – curved
curvas – courbes
01-225.09
01-225.10
01-225.11



mit großen Ringen
with large rings
con anillos
especialmente grandes
avec grandes anneaux

gerade – straight
rectas – droits
01-226.10
10 cm / 4"

gebogen – curved
curvas – courbes
01-227.10
10 cm / 4"

**Sehnenscheren
Tenotomy Scissors
Tijeras para tenotomia
Ciseaux à ténatomie**



Stevens
10,5 cm / 4 1/8" 01-228.10
11,5 cm / 4½" 01-228.11



spitz
agudas
pointed
pointues



gebogen
curved
curvas
courbes



stumpf
romas
blunt
mousses

gerade
straight
rectas
droits



gebogen
curved
curvas
courbes



Mod. Bonn
gerade – straight
rectas – droits
01-232.08
8 cm / 3¼"



gebogen – curved
curvas – courbes
01-233.08
8 cm / 3¼"

**SCHEREN
SCISSORS**

**Augenscheren – Eye Scissors
Tijeras oculares – Ciseaux oculaires**

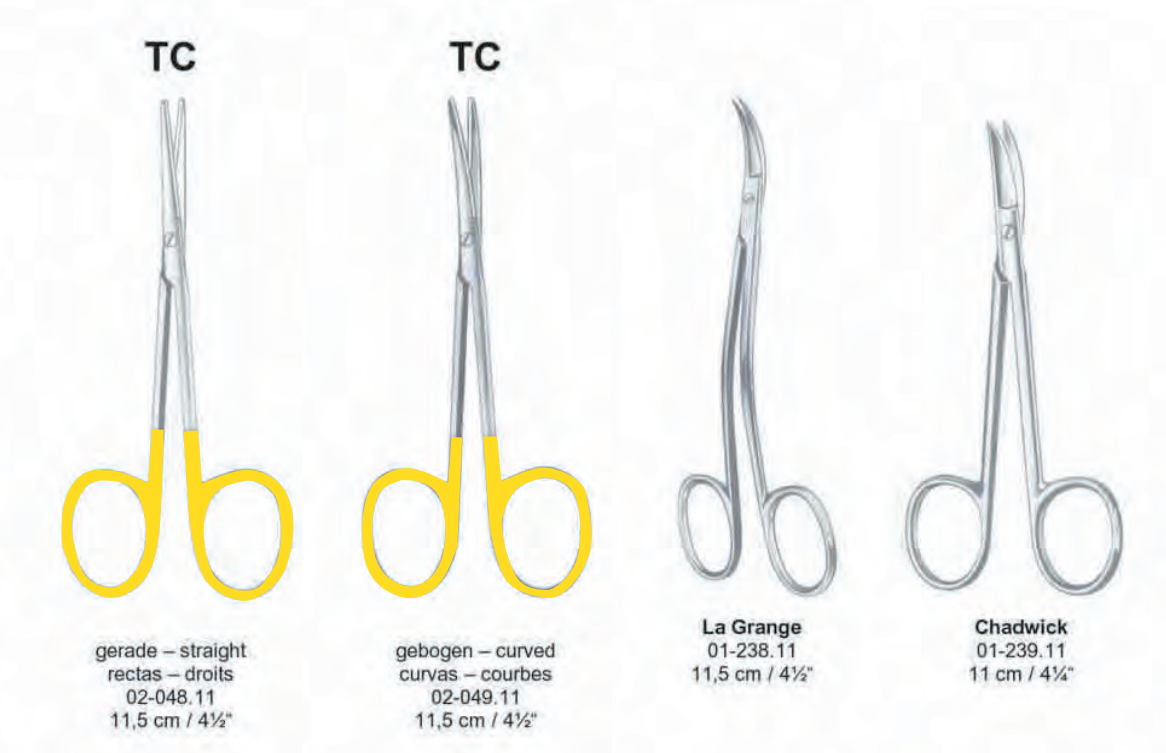
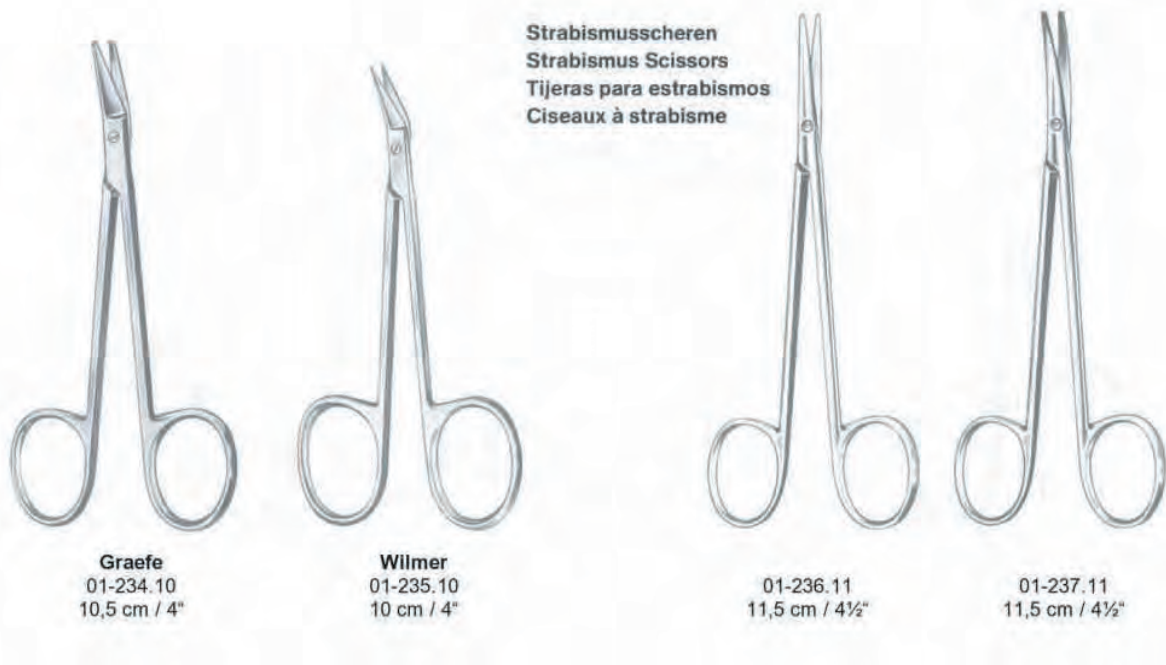

**SCHEREN
 SCISSORS**
**Augenscheren – Eye Scissors
 Tijeras oculares – Ciseaux oculaires**

gerade – straight
 rectas – droits
 01-240.02
 10 cm / 4"



gebogen – curved
 curvas – courbes
 01-240.03
 10 cm / 4"



gerade – straight
 rectas – droits
 01-241.02
 10 cm / 4"



gebogen – curved
 curvas – courbes
 01-241.03
 10 cm / 4"



gerade – straight
 rectas – droits
 01-242.02
 10 cm / 4"



gebogen – curved
 curvas – courbes
 01-242.03
 10 cm / 4"



gerade – straight
 rectas – droits
 01-243.02
 9,5 cm / 3¾"



gebogen – curved
 curvas – courbes
 01-243.03
 9,5 cm / 3¾"



gerade – straight
 rectas – droits
 01-244.02
 9,5 cm / 3¾"



gebogen – curved
 curvas – courbes
 01-244.03
 9,5 cm / 3¾"



gerade – straight
 rectas – droits
 01-245.02
 9,5 cm / 3¾"



gebogen – curved
 curvas – courbes
 01-245.03
 9,5 cm / 3¾"

**SCHEREN
SCISSORS**

**Präparier- (Anatomie) Scheren – Neurochirurgische Scheren
Dissecting Scissors – Neurosurgical Scissors
Tijeras para disección – Tijeras para neurocirugia
Ciseaux à préparation – Ciseaux pour neurochirurgie**

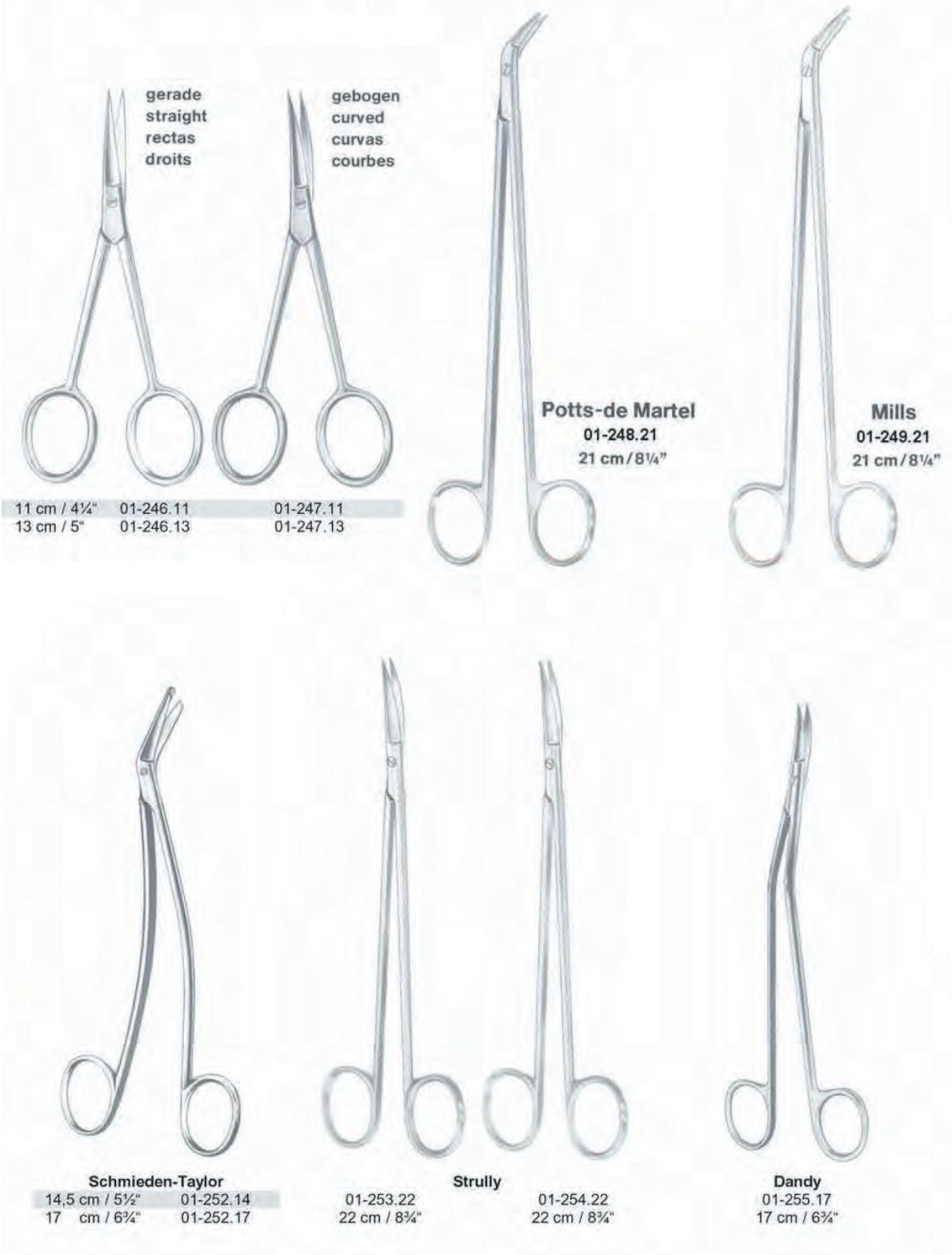

**SCHEREN
 SCISSORS**
**Ligaturscheren – Ligature Scissors
 Tijeras para ligaduras – Ciseaux à ligatures**

Littauer
 01-256.14
 14 cm / 5½"



Spencer
 01-257.09
 9 cm / 3½"



Spencer
 01-257.10
 10,5 cm / 4 1/8"



Spencer
 01-257.12
 12 cm / 4¾"



Spencer-Fino
 01-258.11
 11 cm / 4¼"



01-259.16
 16 cm / 6¼"



Shortbent
 01-260.09
 9 cm / 3½"



Northbent
 01-260.12
 12,5 cm / 5"

**SCHEREN
SCISSORS**

**Ligaturscheren – Ligature Scissors
Tijeras para ligaduras – Ciseaux à ligatures**



01-261.11
11,5 cm / 4½"



Ligittler
01-262.11
11,5 cm / 4½"



Heath
01-263.15
15 cm / 6"



01-264.10
10 cm / 4"



Eiselsberg
01-266.11
11 cm / 4½"

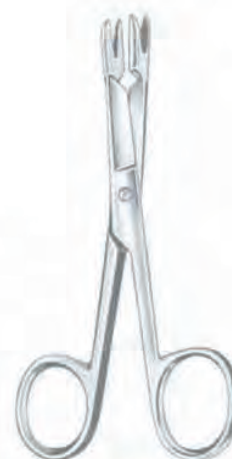

Schoemaker-Loth
01-267.12
12,5 cm / 5"

**SCHEREN
SCISSORS**

**Drahtscheren, Verband- und Kleiderscheren
Wire Cutting Scissors, Bandage and Cloth Scissors
Cizallas para cortar alambre, Tijeras para vendajes y vestidos
Cisailles pour fils, Ciseaux pour pansen ents**

TC



Universal
01-269.18
18 cm / 7"



Smith
01-273.17
17,5 cm / 7"

**SCHEREN
SCISSORS**

Wire Cutting Scissors – Nail Splitting Scissors
Cizallas para cortar alambre – Tijeras para hender las ungas
Cisailles pour fils – Ciseaux à fendre les ongles



gezahnt
saw edge
dentadas
denteles

Harvey
01-276.12
12,5 cm / 5"



13 cm / 5" 01-278.13
15 cm / 6" 01-278.15

**Verbandscheren
Tijeras para vendajes**

**Bandage Scissors
Ciseaux pour pansements**



Lister

9 cm / 4½" 01-279.09
11 cm / 5½" 01-279.11
14 cm / 5½" 01-279.14
15,5 cm / 6" 01-279.15
18 cm / 7" 01-279.18
20 cm / 8" 01-279.20

TC



Lister TC

02-053.18
18 cm / 7"



Lister

18,5 cm / 7¼" 01-281.18
21 cm / 8¼" 01-281.21



Lister-Excentric

16 cm / 6¼" 01-282.16
19 cm / 7½" 01-282.19

**SCHEREN
SCISSORS**

**Verbandscheren – Bandage Scissors
Tijeras para vendajes – Ciseaux pour pansements**

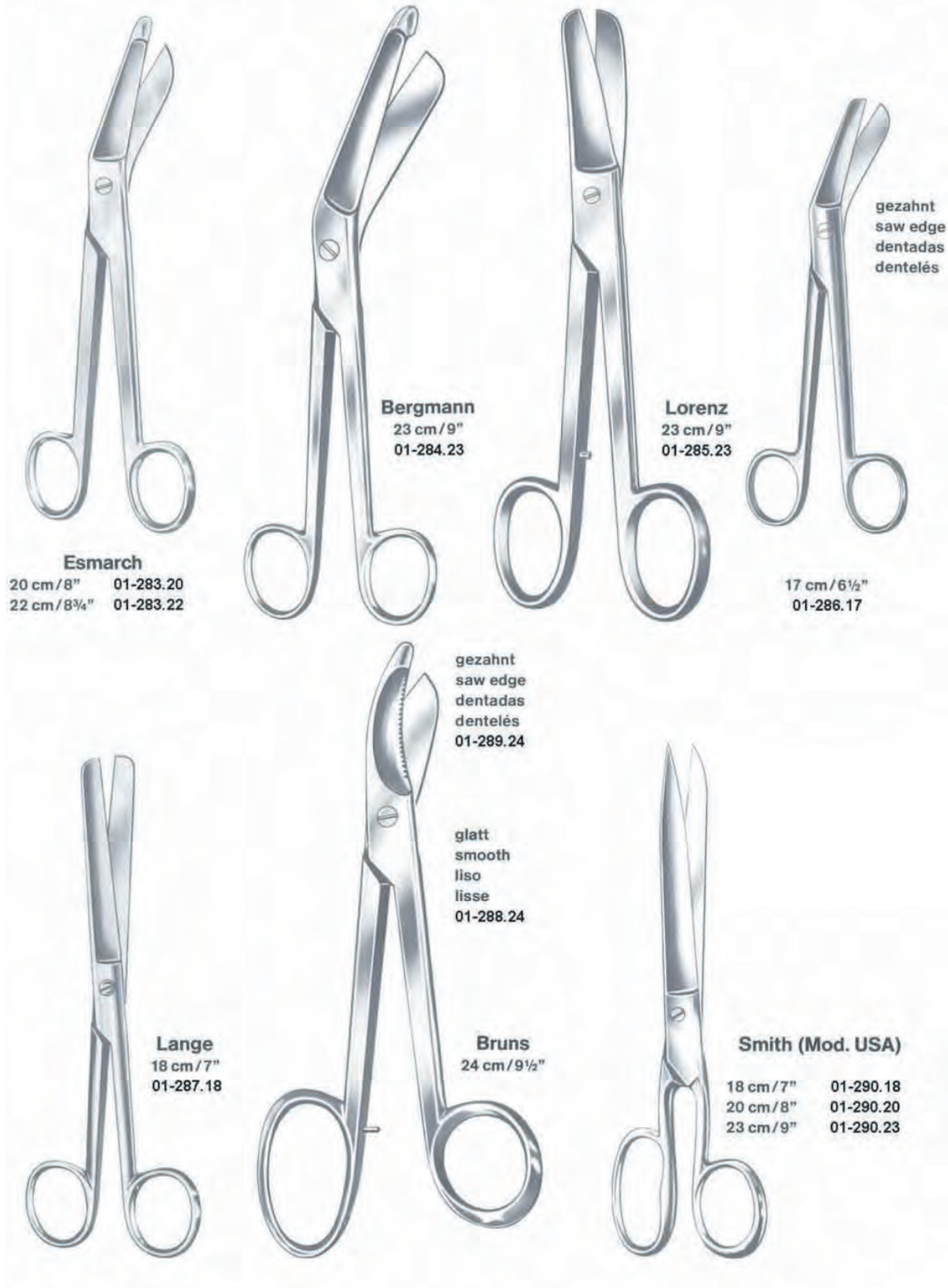

**SCHEREN
SCISSORS**

**Verbandscheren – Bandage Scissors
Tijeras para vendajes – Ciseaux pour pansements**



Knowles
01-293.14
14 cm / 5 1/2"



Knowles
01-294.14
14 cm / 5 1/2"



01-295.13
13 cm / 5"

Kleider- und Gipsscheren
Clothing Scissors, Plaster-of-Paris Shears
Tijeras para vestidos, Cizallas para vendajes enyesados
Cisailles pour pansements et appareils plâtrés

Knochen- und Rippscheren
Bone- and Rib Shears
Cizallas para huesos y costillas
Costotomes, Cisailles pour os

gezahnt
saw edge
dentadas
dentalés



01-296.20
20 cm / 8"



Seutin
01-297.23
23 cm / 9"



01-298.23
23 cm / 9"

**SCHEREN
 SCISSORS**
**Knochen- und Rippscheren – Gippscheren
 Bone- and Rib Shears – Plaster-of-Paris Shears
 Cizallas para huesos y costillas – Cizallas para vendajes enyesados
 Costotomes, Cisailles pour os – Cisailles pour appareils plâtrés**

Gluck
 01-300.22
 22 cm / 8 $\frac{3}{4}$ "



Stille
 01-301.21
 21 cm / 8 $\frac{1}{4}$ "



Stille
 01-302.24
 24 cm / 9 $\frac{1}{2}$ "



Stille

23 cm / 9"	01-303.23
26 cm / 10 $\frac{1}{4}$ "	01-303.26
37 cm / 14 $\frac{1}{2}$ "	01-303.37

**SCHEREN
SCISSORS**

**Kronenscheren – Crown Scissors
Tijeras para coronas – Ciseaux à couronnes**



stumpf
blunt
romas
mousses
01-304.10

spitz
pointed
agudas
pointues
01-305.10

Beebee
gerade – straight
rectas – droits
10,5 cm / 4"



stumpf
blunt
romas
mousses
01-306.10

spitz
pointed
agudas
pointues
01-307.10

Beebee
gebogen – curved
curvas – courbes
10,5 cm / 4"



01-308.10
10,5 cm / 4"

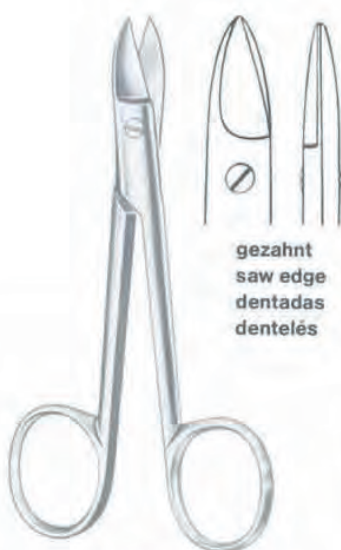

gezahnt
saw edge
dentadas
dentelés

Beebee
01-309.12
12 cm / 4¾"

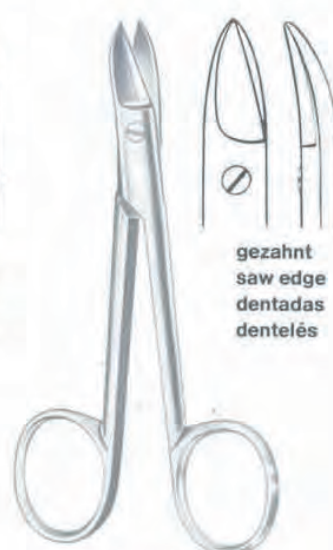

gezahnt
saw edge
dentadas
dentelés

Beebee
01-310.12
12 cm / 4¾"

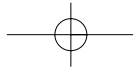

**SCHEREN
SCISSORS**

**Zahnfleischscheren – Gum Scissors
Tijeras para encias – Ciseaux à gencives**



gezahnt
saw edge
dentadas
denteles

Goldmann-Fox

01-315.13
13 cm / 5"

01-316.13
13 cm / 5"



TC

TC

Goldmann-Fox TC

02-054.13
13 cm / 5"

02-055.13
13 cm / 5"

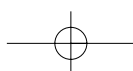

**SCHEREN
SCISSORS**

**Zahnfleischscheren – Gum Scissors
Tijeras para encias – Ciseaux à gencives**

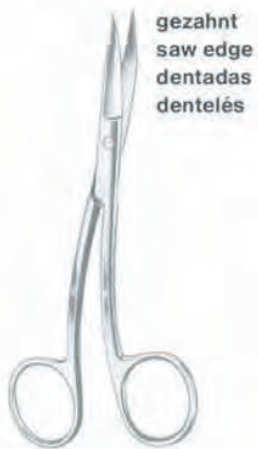

gezahnt
saw edge
dentadas
denteles

Goldman-Fox
(Spezial)
01-317.13
13 cm / 5"

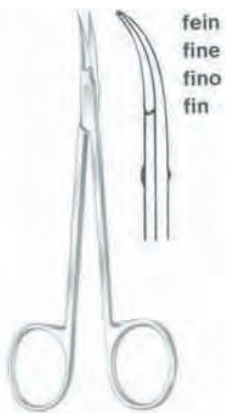

fein
fine
fino
fin

01-318.11
11,5 cm / 4½"



Quinby

01-319.12
12 cm / 4¾"

01-320.12
12 cm / 4¾"



gezahnt
saw edge
dentadas
denteles

Dean
01-321.17
17 cm / 6¾"



gezahnt
saw edge
dentadas
denteles

Dean
01-322.17
17 cm / 6¾"



gezahnt
saw edge
dentadas
denteles

Locklin
01-324.16
16,5 cm / 6½"

01-325.16
16,5 cm / 6½"

**SCHEREN
SCISSORS**

**Zahnfleischscheren – Gum Scissors
Tijeras para encias – Ciseaux à gencives**

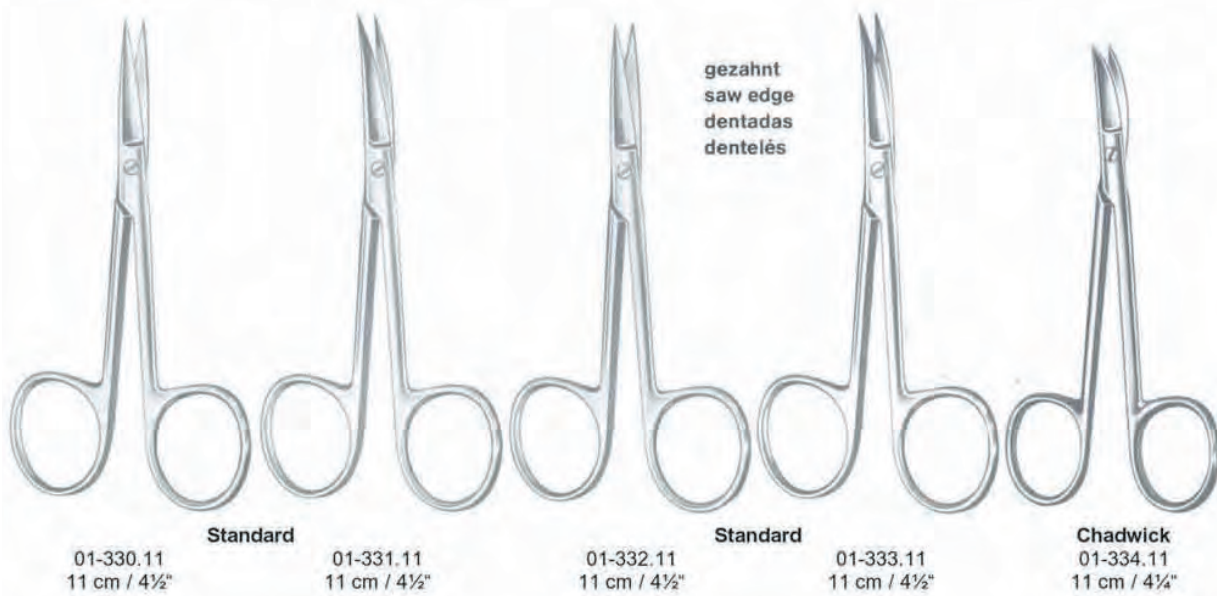
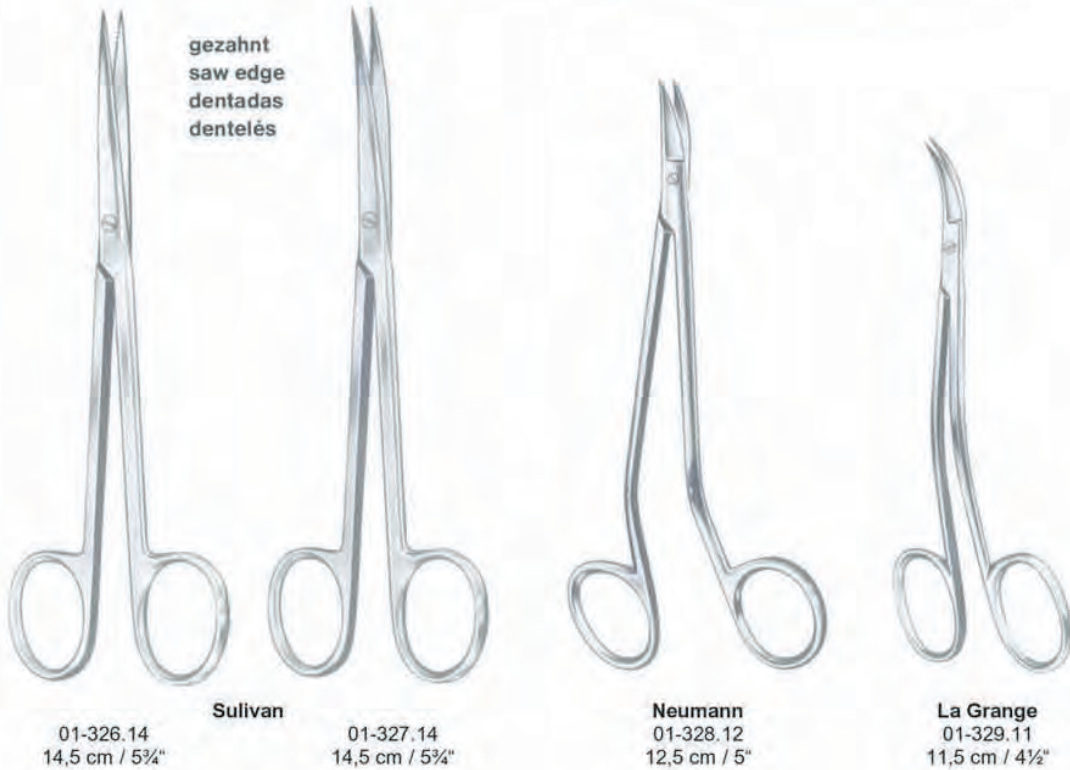

**SCHEREN
SCISSORS**

**Hautscheren – Cuticle Scissors
Tijeras cuticulares – Ciseaux à envies**



10 cm / 4"	01-335.10	01-336.10
11 cm / 4 1/4"	01-335.11	01-336.11

**Nagelscheren – Nail Scissors
Tijeras cuticulares – Ciseaux à ongles**

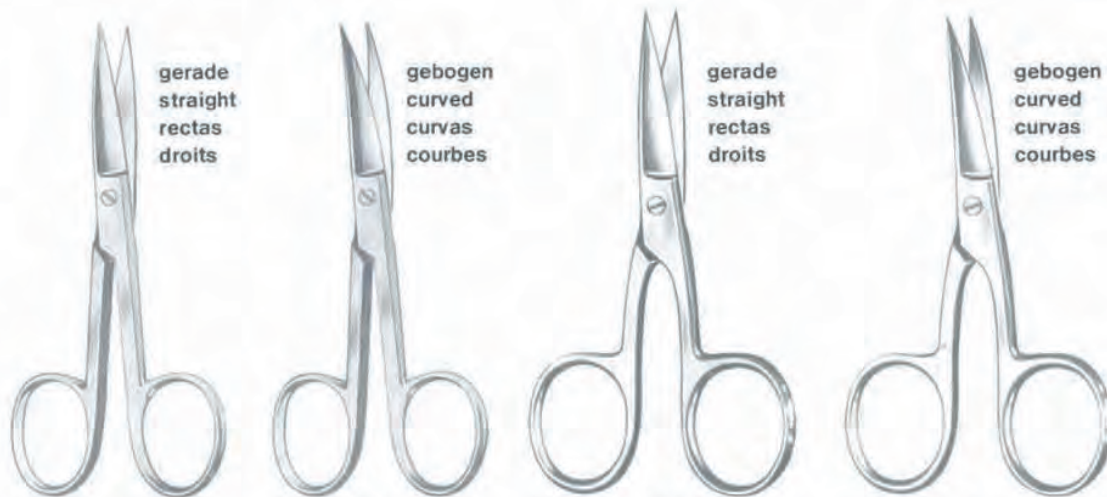

9 cm / 3 1/2"	01-337.09	01-338.09	01-339.09	01-340.09
10,5 cm / 4 1/8"	01-337.10	01-338.10	01-339.10	01-340.10



**PINZETTEN
FORCEPS**

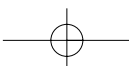
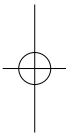
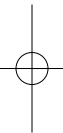
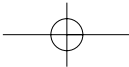

**Pinzetten
Forceps**

**Anatomische Pinzetten – Dressing Forceps
Pinces à disséquer – Pinzas de disección**

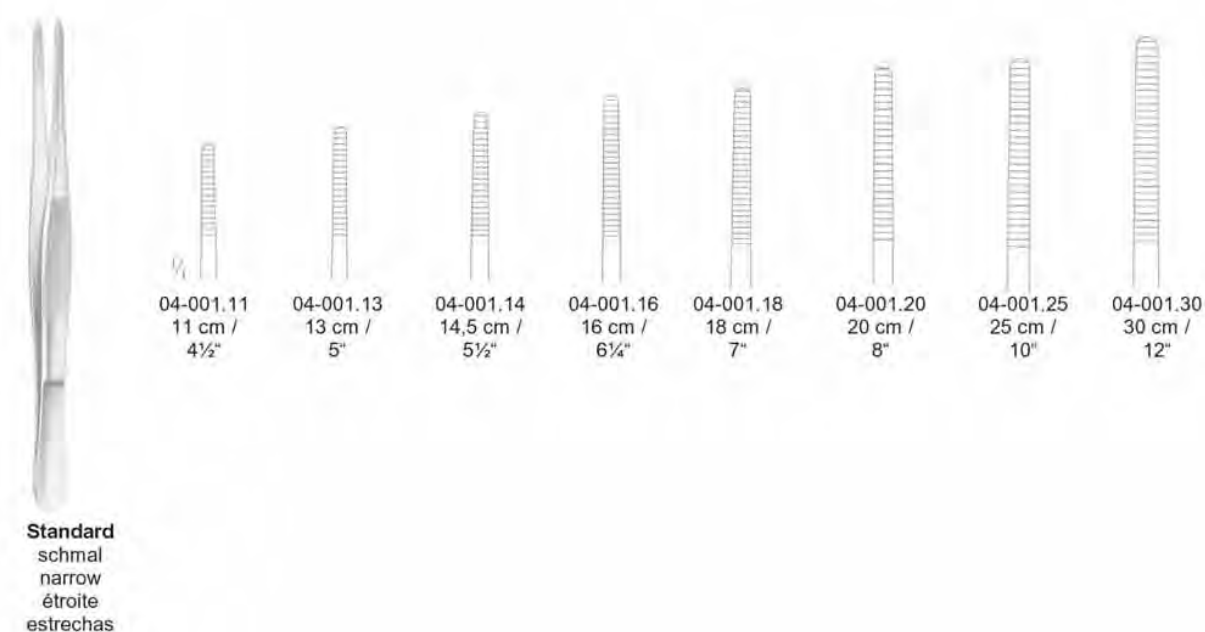
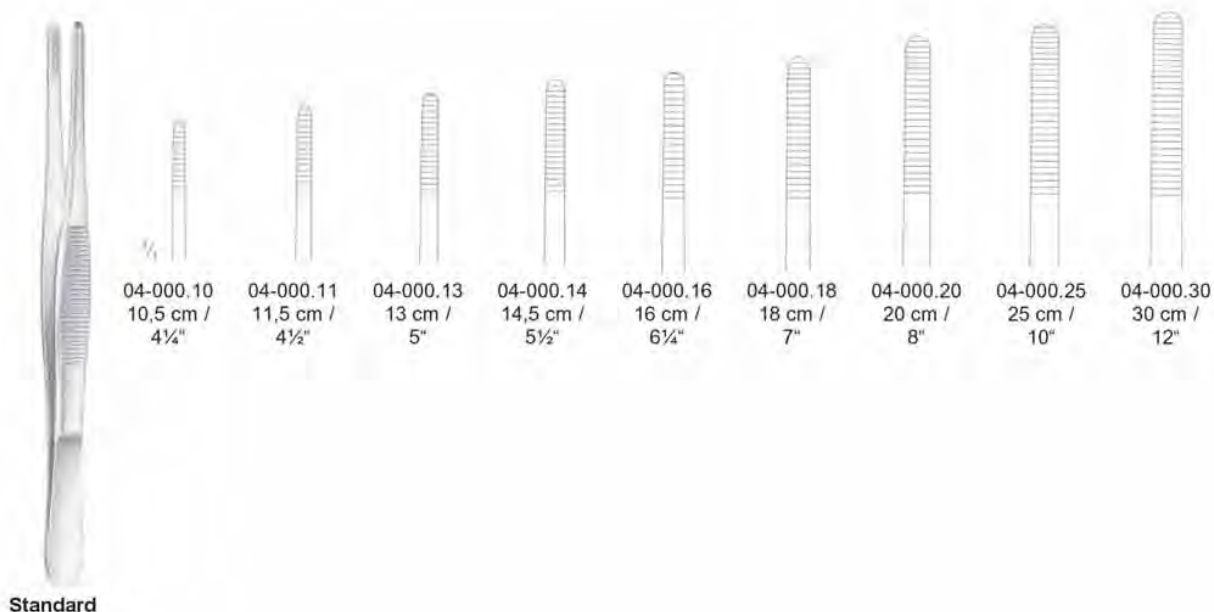

**Pinzetten
Forceps**

**Anatomische Pinzetten – Dressing Forceps
Pinces à disséquer – Pinzas de disección**

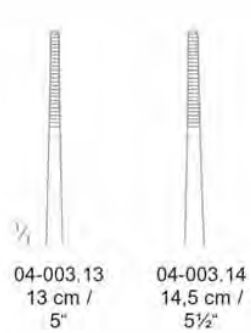
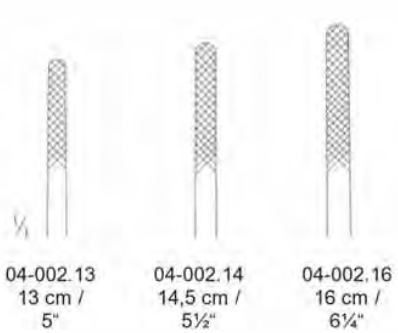

Stille

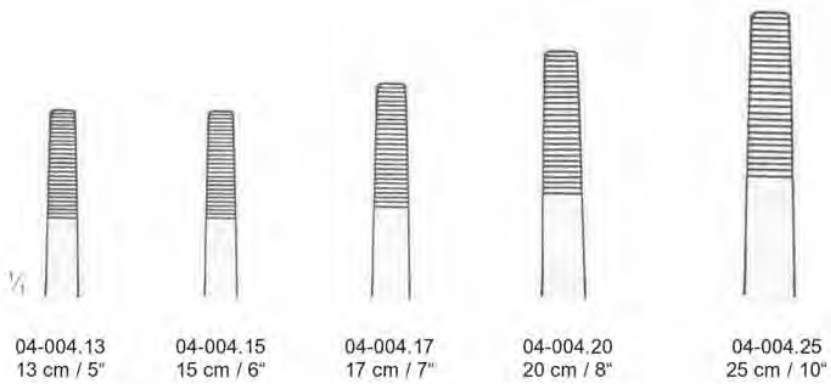

**Pinzetten
Forceps**

**Anatomische Pinzetten – Dressing Forceps
Pinces à disséquer – Pinzas de disección**

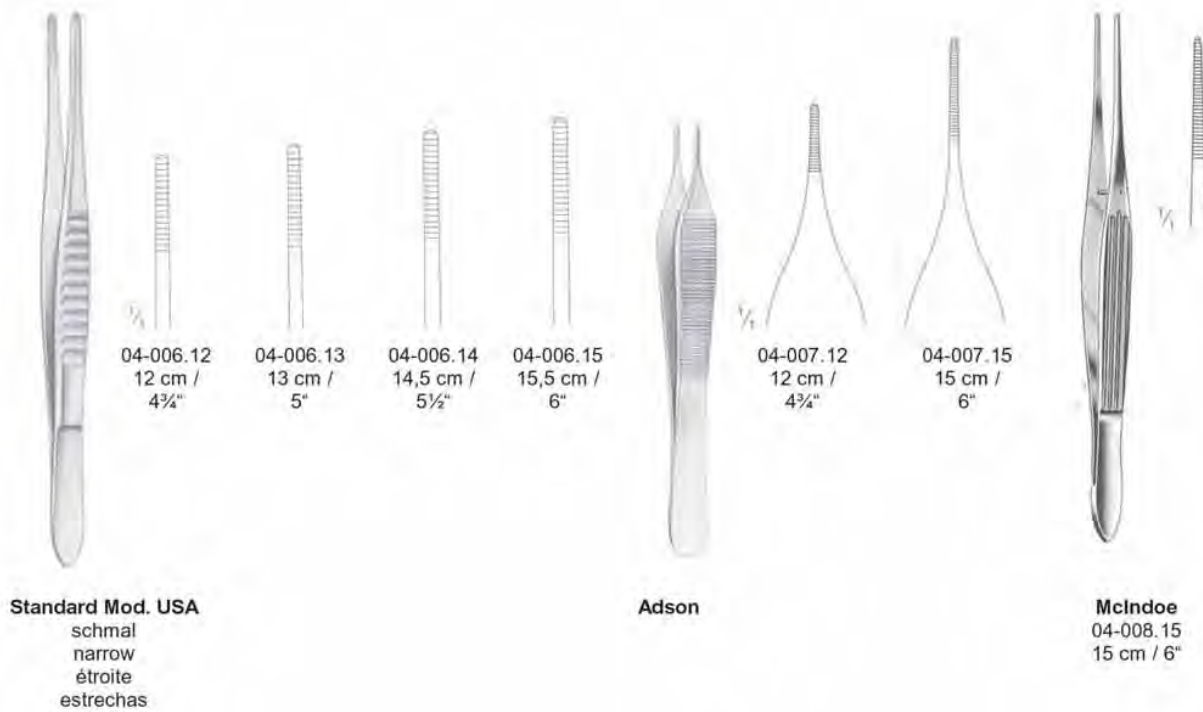
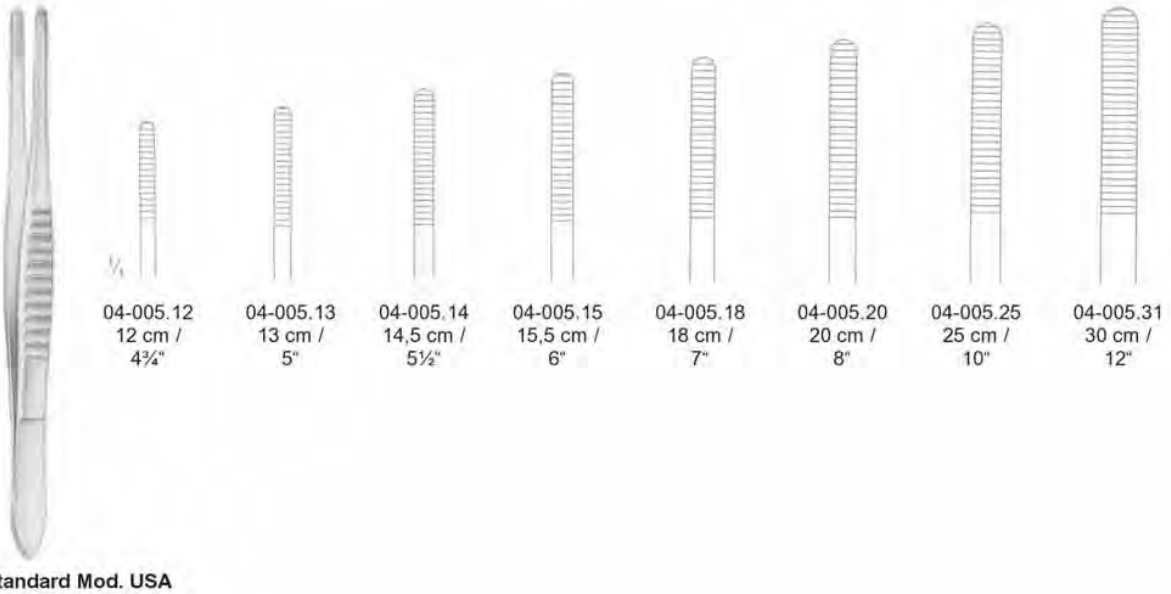

**Pinzetten
Forceps**

**Anatomische Pinzetten – Dressing Forceps
Pinces à disséquer – Pinzas de disección**

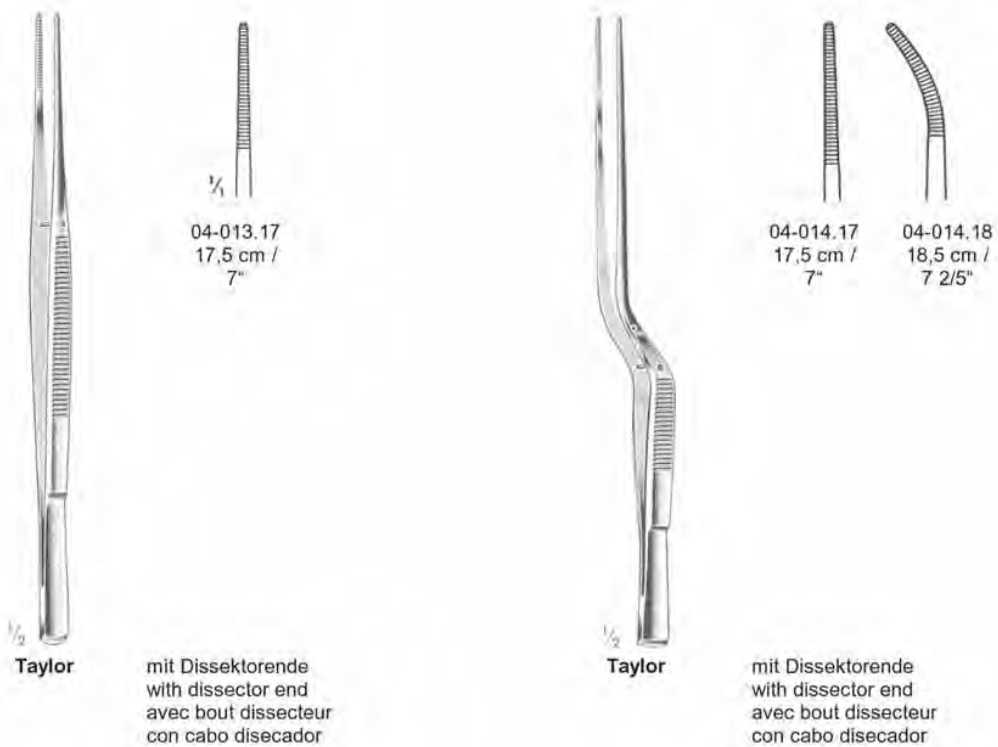
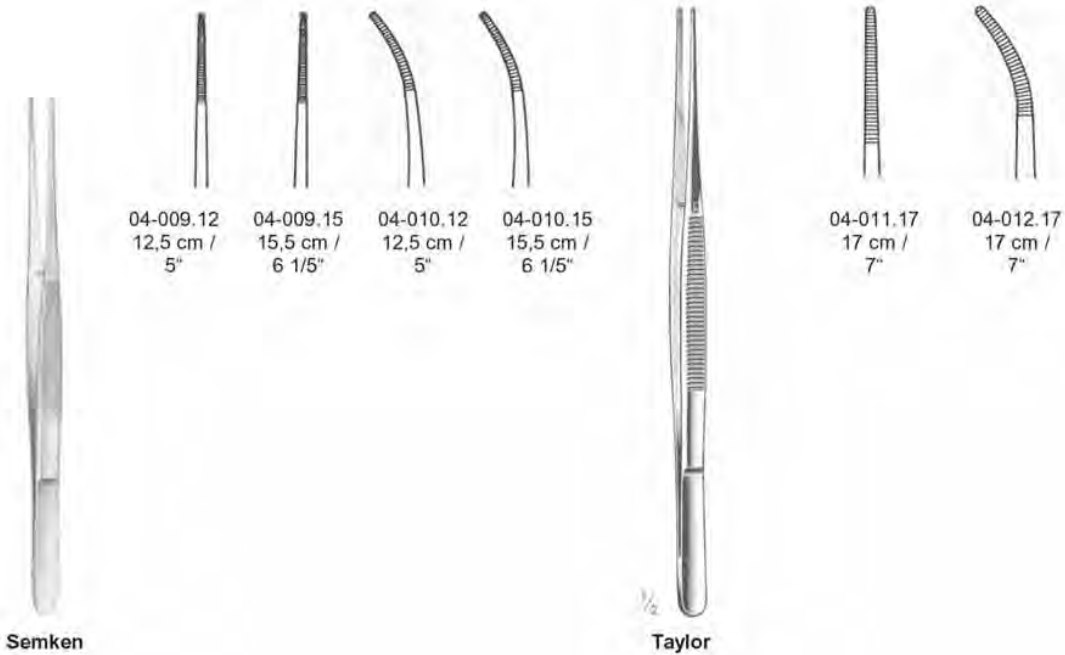

**Pinzetten
Forceps**

**Anatomische Pinzetten – Dressing Forceps
Pincés à disséquer – Pinzas de disección**



Gerald



04-015.18
17,5 cm / 7"



04-016.18
17,5 cm / 7"



Cushing



04-017.17
18 cm / 7"



04-018.17
18 cm / 7"



Potts-Smith



04-019.18
18 cm / 7"



04-019.21
21 cm / 8¼"



04-019.25
25 cm / 10"



04-019.30
30 cm / 12"



04-020.18
18 cm / 7"



04-020.21
21 cm / 8¼"

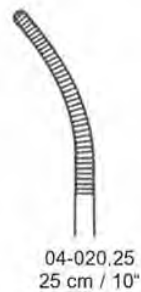

04-020.25
25 cm / 10"

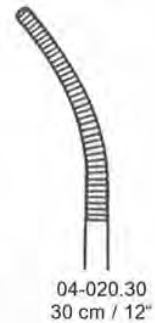

04-020.30
30 cm / 12"

**Pinzetten
Forceps**

**Anatomische Pinzetten – Dressing Forceps
Pinces à disséquer – Pinzas de disección**

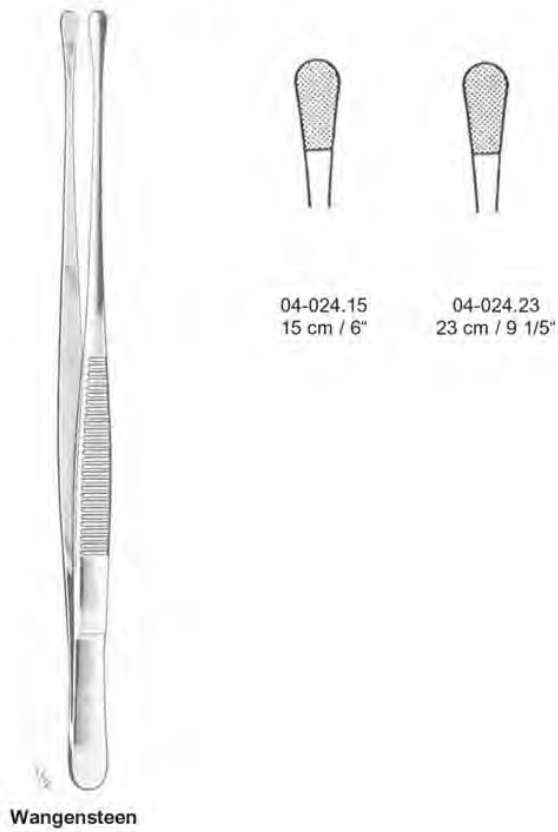
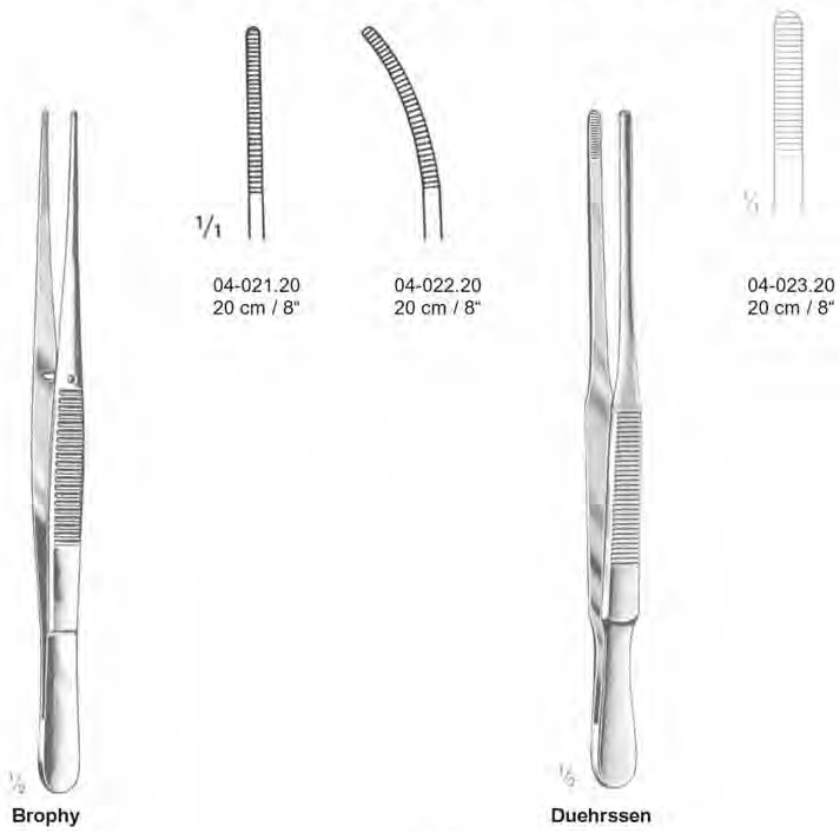

**Pinzetten
Forceps**

**Chirurgische Pinzetten – Tissue Forceps
Pincés à griffes – Pinzas de disección con dientes**

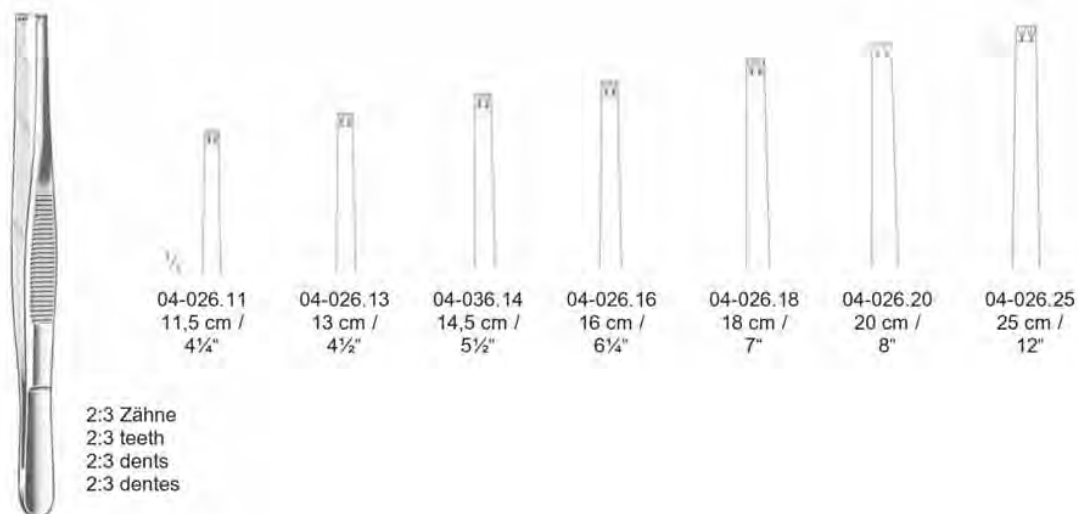
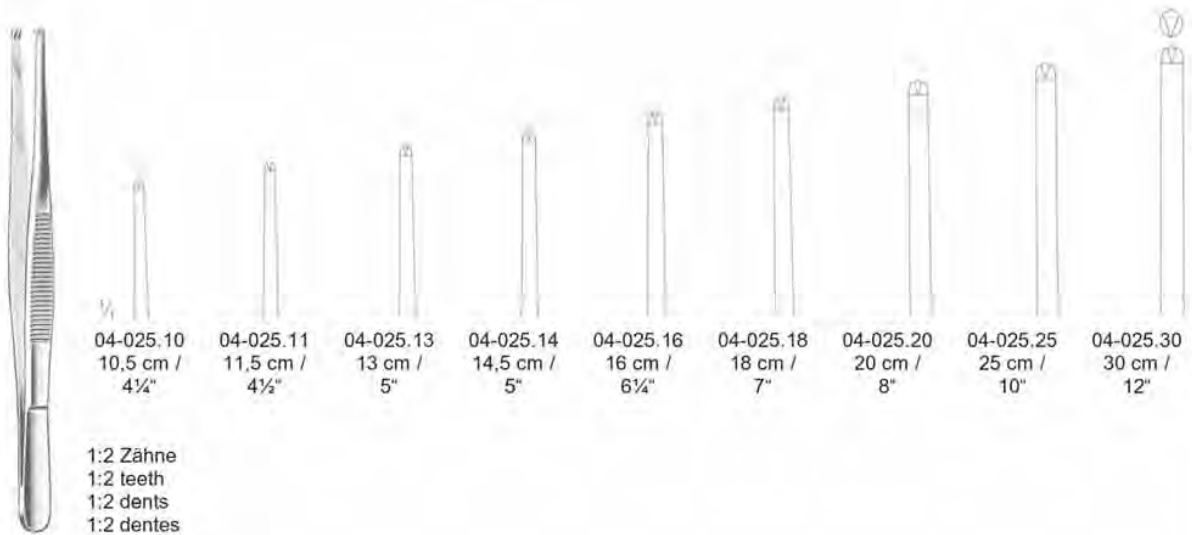

**Pinzetten
Forceps**

**Chirurgische Pinzetten – Tissue Forceps
Pincés à griffes – Pinzas de disección con dientes**

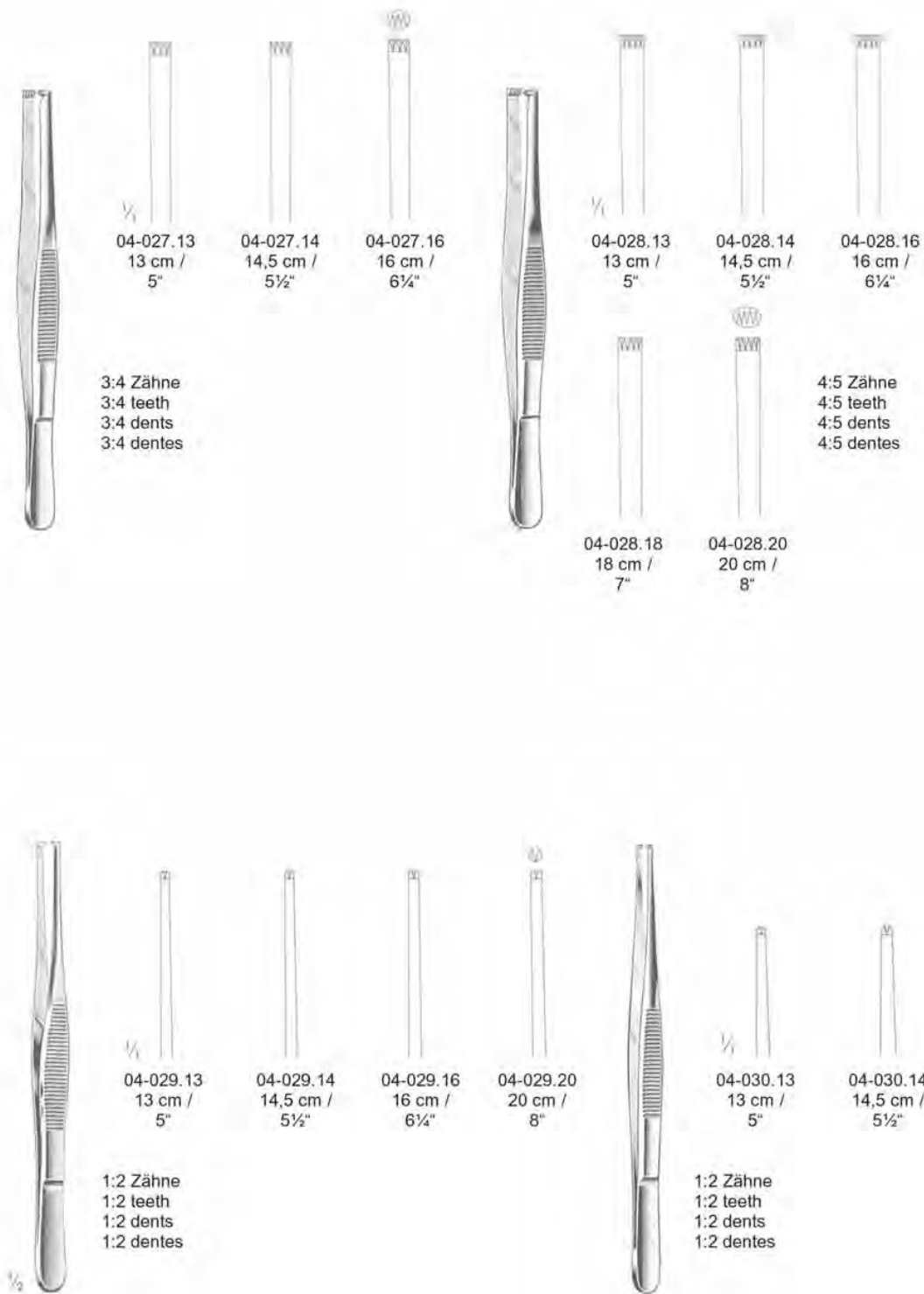

**Pinzetten
Forceps**

**Chirurgische Pinzetten – Tissue Forceps
Pinces à griffes – Pinzas de disección con dientes**



Stille



04-031.15
15 cm / 6"

1:2 Zähne
1:2 teeth
1:2 dents
1:2 dentes



Stille



04-032.15
15 cm / 6"

2:3 Zähne
2:3 teeth
2:3 dents
2:3 dentes



Mod. USA



04-033.12
12 cm /
4¾"



04-033.13
13 cm /
5"



04-033.14
14,5 cm /
5½"



04-033.15
15,5 cm /
6"



04-033.18
18 cm /
7"



04-033.20
20 cm /
8"



04-033.25
25 cm /
10"



04-033.30
30 cm /
12"

1:2 Zähne
1:2 teeth
1:2 dents
1:2 dentes

**Pinzetten
Forceps**

**Chirurgische Pinzetten – Tissue Forceps
Pincés à griffes – Pinzas de disección con dientes**

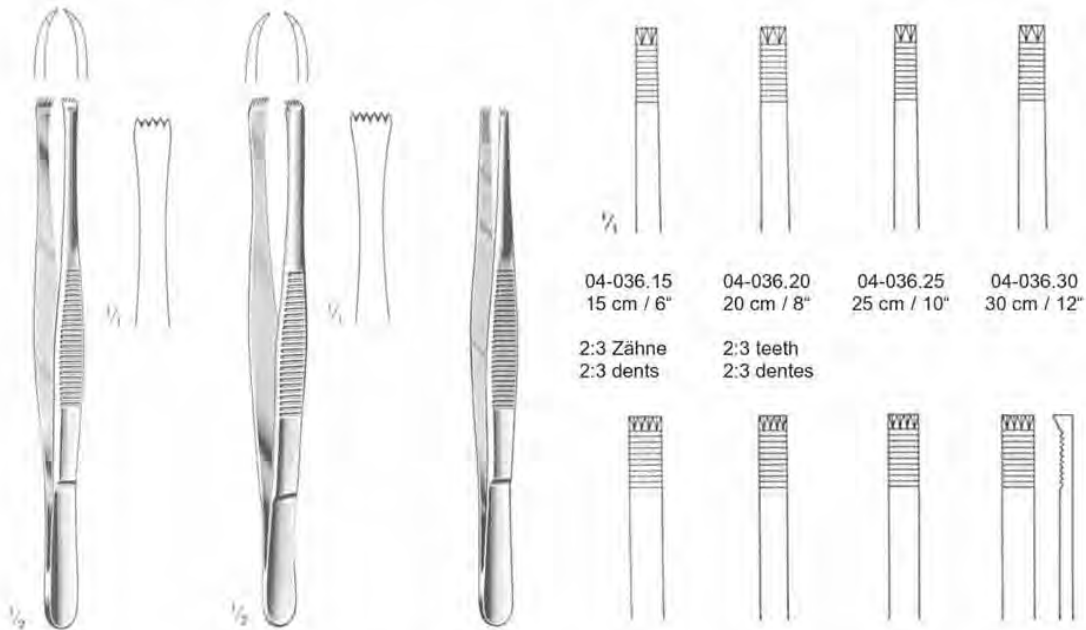

04-036.15 15 cm / 6"
04-036.20 20 cm / 8"
04-036.25 25 cm / 10"
04-036.30 30 cm / 12"

2:3 Zähne
2:3 dents

2:3 teeth
2:3 dentes

04-037.13 13 cm / 5"
04-037.15 15 cm / 6"
04-037.20 20 cm / 8"
04-037.25 25 cm / 10"

4:5 Zähne
4:5 dents

4:5 teeth
4:5 dentes

Stone
04-034.15
15 cm / 6"

4:5 Zähne
4:5 teeth
4:5 dents
4:5 dentes

Lerche
04-035.15
15 cm / 6"

5:6 Zähne
5:6 teeth
5:6 dents
5:6 dentes

Adlerkreuz



04-038.12 12 cm / 4¾"
04-038.15 15 cm / 6"

1:2 Zähne
1:2 teeth
1:2 dents
1:2 dentes

Adson

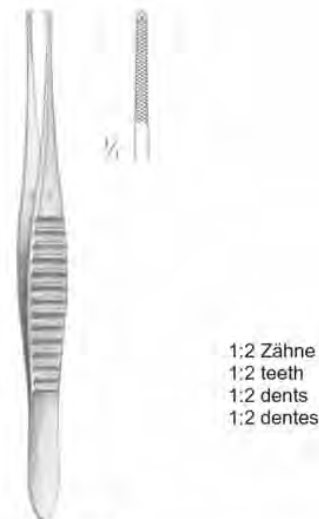

1:2 Zähne
1:2 teeth
1:2 dents
1:2 dentes

Gillies
04-039.15
15 cm / 6"

**Pinzetten
Forceps**

**Chirurgische Pinzetten – Tissue Forceps
Pinces à griffes – Pinzas de disección con dientes**

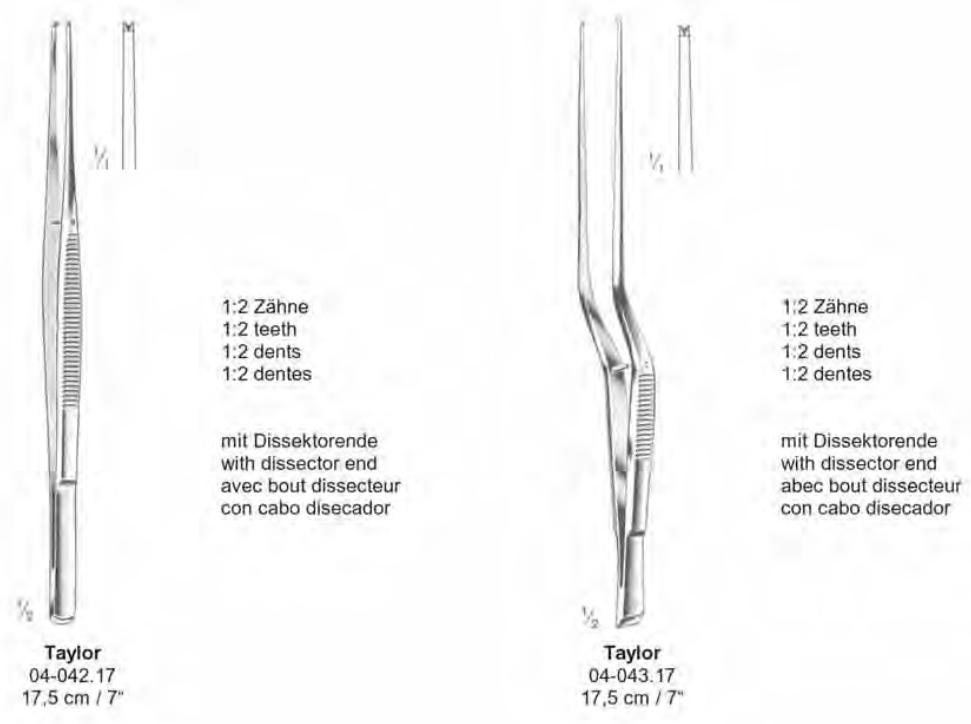
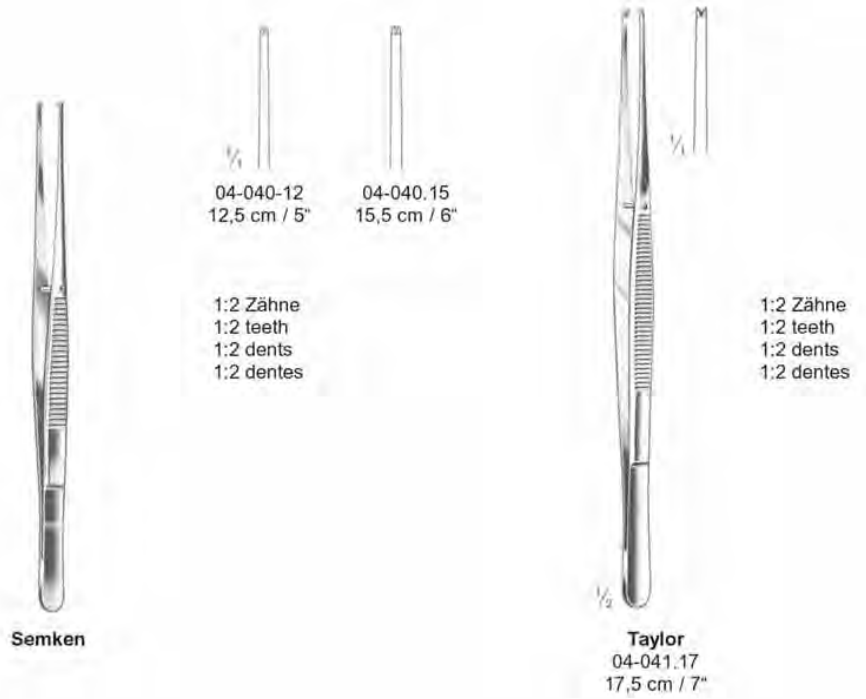

**Pinzetten
Forceps**

**Chirurgische Pinzetten – Tissue Forceps
Pinces à griffes – Pinzas de disección con dientes**

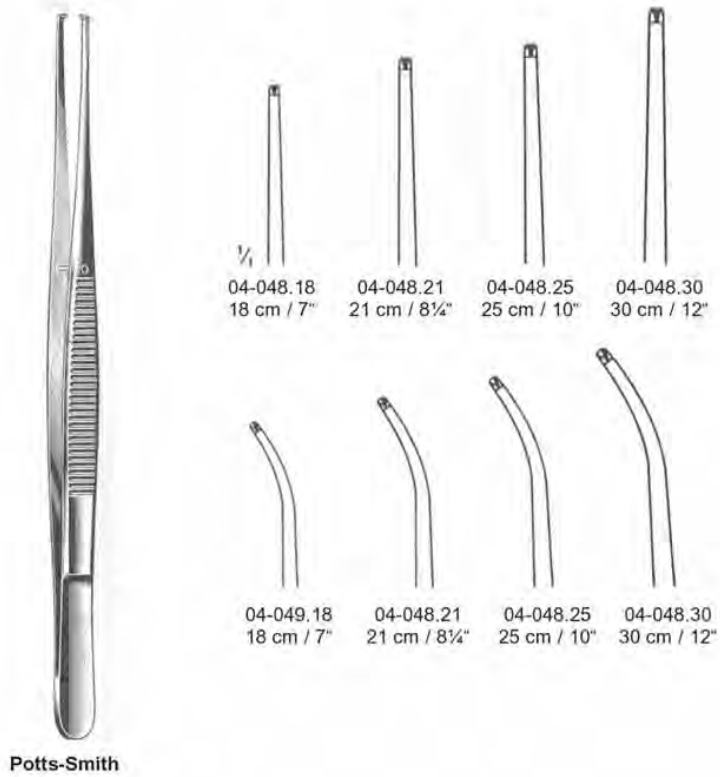
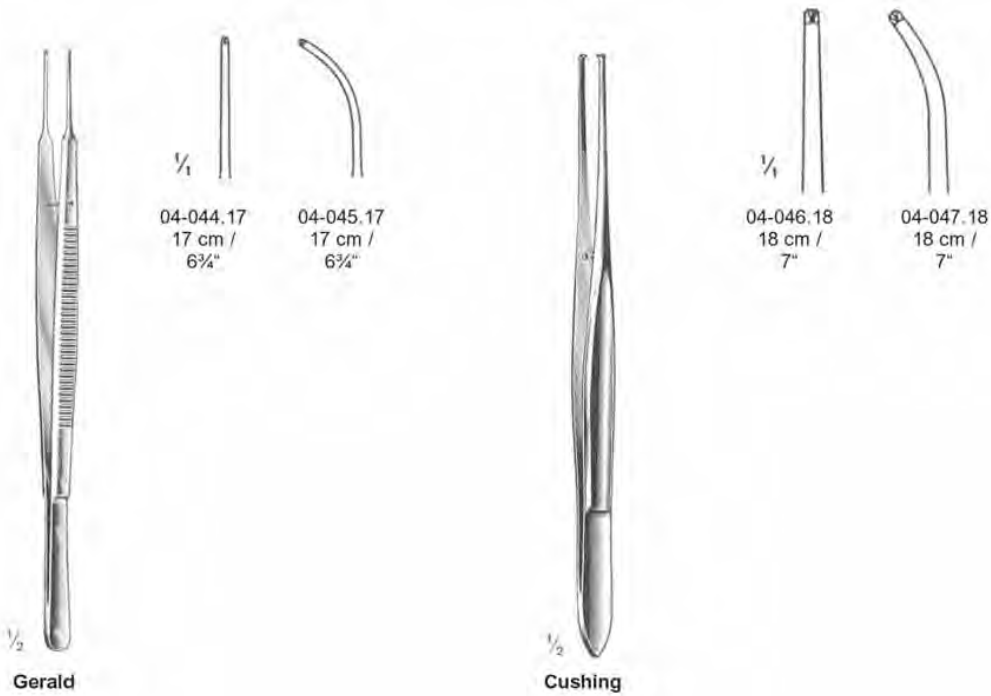

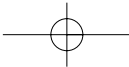

**Pinzetten
Forceps**

**Mikro-Pinzetten – Micro Forceps
Pincettes pour micro-chirurgie – Micro-pinzas**



Brophy



Adson-Brown
04-052.12
12 cm / 4¾"



Adson-Brown
04-052.15
15 cm / 6"



Micro-Adson
04-053.12
12 cm / 4¾"



Micro-Adson
04-053.15
15 cm / 6"

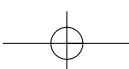

**Pinzetten
Forceps**

**Chirurgische Pinzetten – Tissue Forceps
Pinces à griffes – Pinzas de disección con dientes**



Duval
04-054.14
14 cm / 5½"



Russ. Model



04-055.15
15 cm / 6"



04-055.20
20 cm / 8"



04-055.25
25 cm / 10"

**Pinzetten
Forceps**

**Chirurgische Pinzetten – Tissue Forceps
Pincés à griffes – Pinzas de disección con dientes**

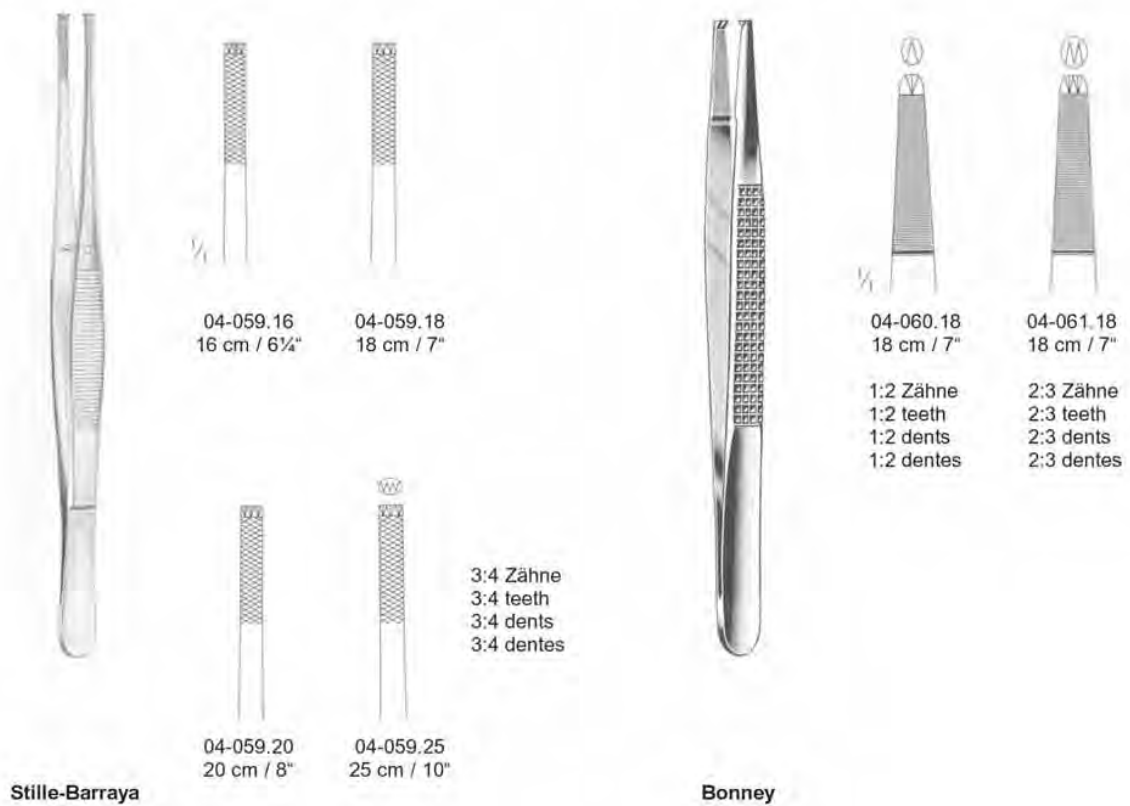
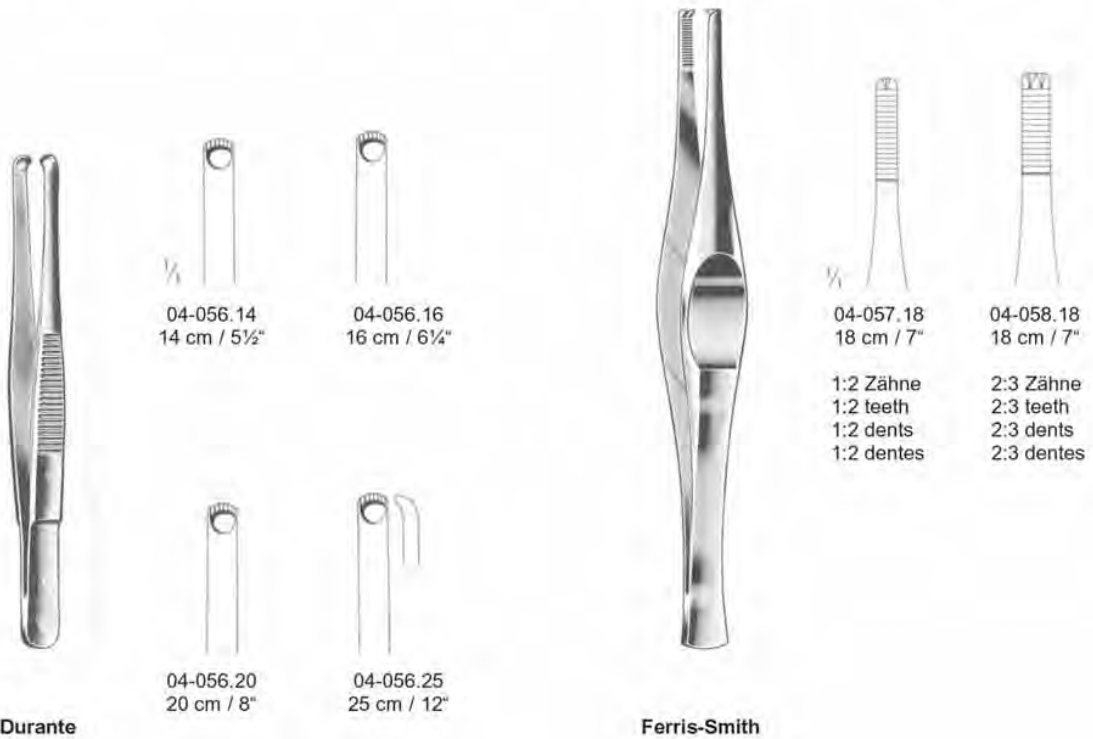

**Pinzetten
Forceps**

**Fasspinzetten – Grasping Forceps
Pincers pour préhension – Pinzas para coger**



Mayo-Russ.



04-062.23
23 cm / 9"



Singley-Tuttle

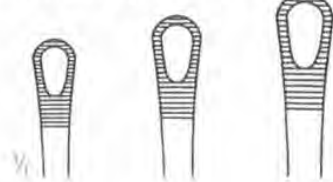

04-063.15
15 cm / 6"

04-063.18
18 cm / 7"

04-063.23
23 cm / 9"



Nelson



04-064.15
15 cm / 6"

04-064.18
18 cm / 7"

04-064.20
20 cm / 8"



04-064.23
23 cm / 9"

04-064.30
30 cm / 12"

04-064.33
33 cm / 13 1/5"

**Pinzetten
Forceps**

**Fasspinzetten – Grasping Forceps
Pinces pour préhension – Pinzas para coger**



Collin-Duval
04-065.20
20 cm / 8"
14 mm

**Pinzetten
Forceps**

**Splitterpinzetten – Splinter Forceps
Pincas à échardes – Pinzas para espinas**



Feilchenfeld



04-066.08
8 cm / 3"



04-066.09
9 cm / 3½"



04-066.11
11,5 cm / 4½"



Hunter



04-067.10
10,5 cm /
4¼"



04-068.10
10,5 cm /
4¼"



Walter-Carmalt



04-069.10
10,5 cm /
4¼"



04-070.10
10,5 cm /
4¼"

**Pinzetten
Forceps**

**Cilienpinzetten – Cilia Forceps
Pincas à épiler les cils – Pinzas depilatorias**



Shaaf
04-072.09
9 cm / 3 1/2"



Littauer
04-073.09
9 cm / 3 1/2"



Douglas
04-074.09
9 cm / 3 1/2"



Douglas
04-075.09
9 cm / 3 1/2"



Beer



04-076.06
6,5 cm /
2 3/5"



04-076.08
8 cm /
3 1/5"



04-076.09
9 cm /
3 1/2"



Barraquer
04-079.10
10,5 cm / 4 1/4"

**Pinzetten
Forceps**

**Pinzetten mit Hartmetalleinsätzen
Forceps with tungsten carbide inserts
Pincers avec plaquettes en carbure de tungstène
Pinzas con bocas de carburo de tungsteno**

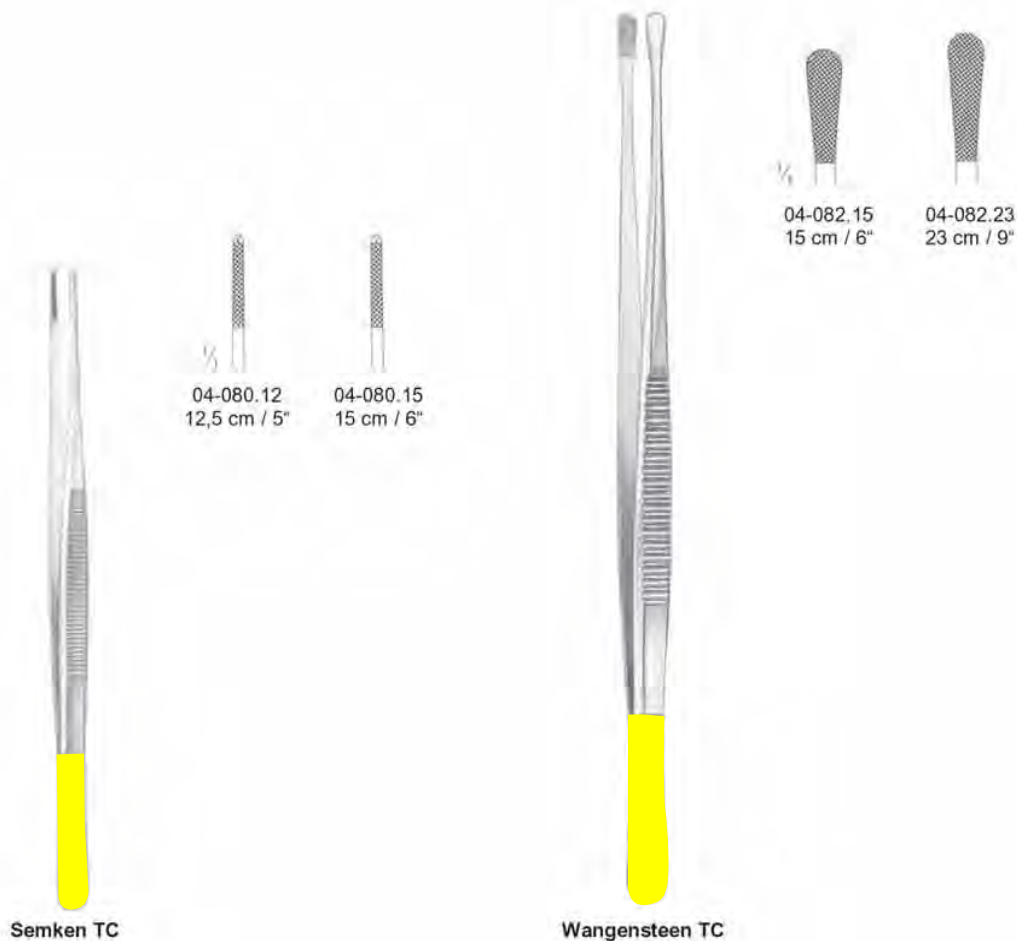

**Pinzetten
Forceps**

**Pinzetten mit Hartmetalleinsätzen
Forceps with tungsten carbide inserts
Pincès avec plaquettes en carbure de tungstène
Pinzas con bocas de carburo de tungsteno**



Adson-Brown TC
04-083.12
12 cm / 4 3/4"



Adson TC



04-084.12
12 cm /
4 3/4"

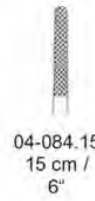

04-084.15
15 cm /
6"



04-085.12
12 cm /
4 3/4"



04-085.15
15 cm /
6"



Cushing TC
04-087.18
18 cm / 7"

mit Dissektorende
with dissector end
avec bout dissecteur
con cabo disecador



Cushing TC
04-088.18
18 cm / 7"

mit Dissektorende
with dissector end
avec bout dissecteur
con cabo disecador



Cushing-Taylor TC
04-089.18
18 cm / 7"

**Pinzetten
Forceps**

**Pinzetten mit Hartmetalleinsätzen
Forceps with tungsten carbide inserts
Pincès avec plaquettes en carbure de tungstène
Pinzas con bocas de carburo de tungsteno**



Potts-Smith TC



04-090.15
15 cm / 6"



04-090.18
18 cm / 7"

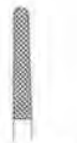

04-090.21
21 cm / 8 2/5"



04-090.23
23 cm / 9"

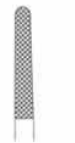

04-090.25
25 cm / 10"



Oehler TC

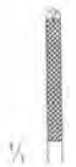

04-091.14
14,5 cm / 5"



04-091.16
16 cm / 6 1/2"

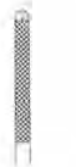

04-091.18
18 cm / 7"



04-091.20
20 cm / 8"



04-091.25
25 cm / 10"

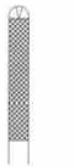

04-091.30
30 cm / 12"

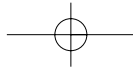

**Pinzetten
Forceps**

**Pinzetten mit Hartmetalleinsätzen
Forceps with tungsten carbide inserts
Pincès avec plaquettes en carbure de tungstène
Pinzas con bocas de carburo de tungsteno**



De Bakey TC



04-092.15
15 cm / 6"



04-092.20
20 cm / 8"



04-092.24
24 cm / 9½"

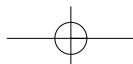

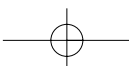
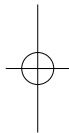
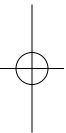
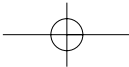

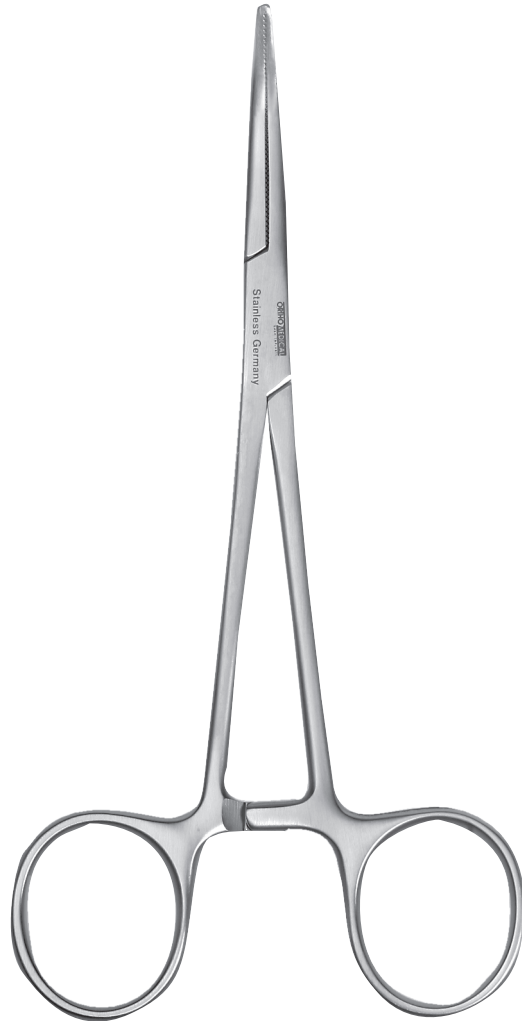

KLEMMEN FORCEPS

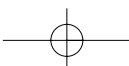
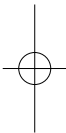
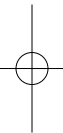
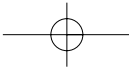

**KLEMMEN
FORCEPS**

Artery Forceps
Pincés hemostáticas
Pinzas hemostáticas



Spencer-Wells



08-001.13
13 cm / 5"



08-001.15
15 cm / 6"



08-001.18
18 cm / 7"



08-001.20
20 cm / 8"



08-002.13
13 cm / 5"



08-002.15
15 cm / 6"



08-002.18
18 cm / 7"



08-002.20
20 cm / 8"



Chaput
08-003.13
13 cm / 5"



Tuffier
08-004.13
13 cm / 5"

**KLEMMEN
FORCEPS**

Tissue Seizing Forceps
Pincés pour saisir le tissu
Pinzas para coger tejidos

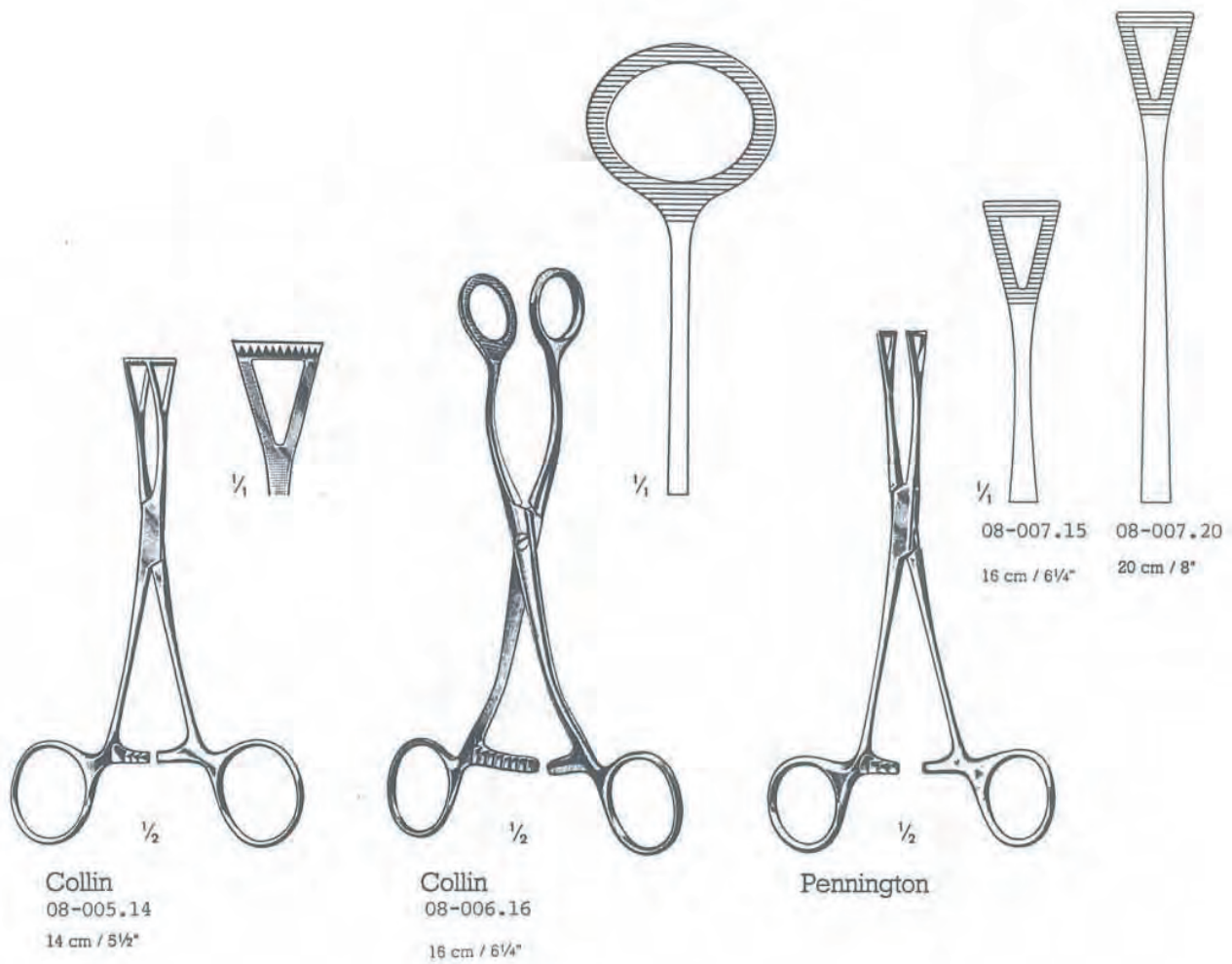

**KLEMMEN
FORCEPS**

Artery Forceps, Angiotribes
Pincas hemostaticas, pincas-clamps a pression progressive
Pinzas hemostaticas, pinzas-clamps de presion progresiva

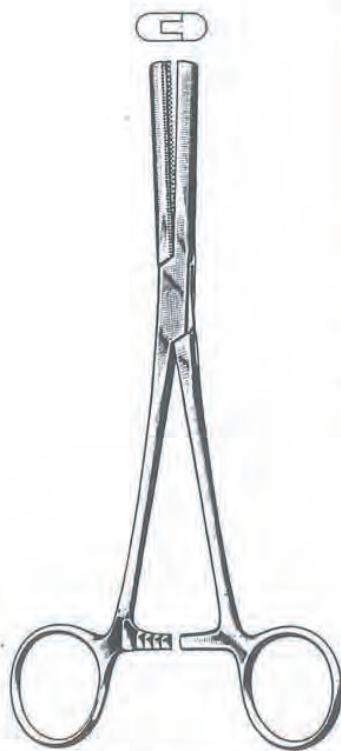

Fergusson

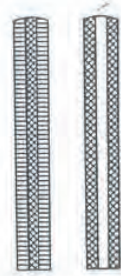

08-008.16
16 cm / 6 1/4"

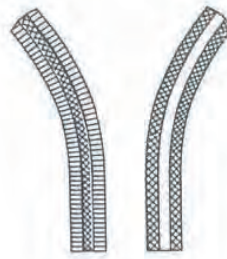

08-009.16
16 cm / 6 1/4"

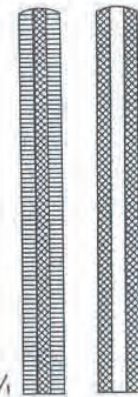

08-010.20
20 cm / 8"

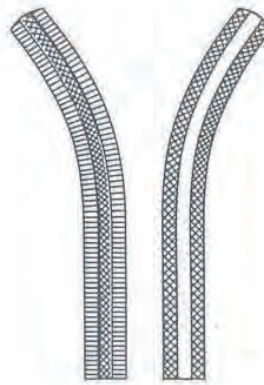

08-011.20
20 cm / 8"



Baby-Mixter
08-012.14
14 cm / 5 1/2"



08-013.10



08-014.10



Hartmann
9 cm / 3 1/2"

**KLEMMEN
FORCEPS**

Artery Forceps
Pincès hemostatiques
Pinzas hemostaticas



Halsted-Mosquito

08-015.12	08-015.14	08-016.12	08-016.14
12,5 cm / 5"	14 cm / 5½"	12,5 cm / 5"	14 cm / 5½"
08-017.12	08-017.14	08-018.12	08-018.14
12,5 cm / 5"	14 cm / 5½"	12,5 cm / 5"	14 cm / 5½"

1: z Teeth, Dientes, Dents

**KLEMMEN
FORCEPS**

Artery Forceps
Pincas hemostatiques
Pinzas hemostaticas



Halsted-Mosquito

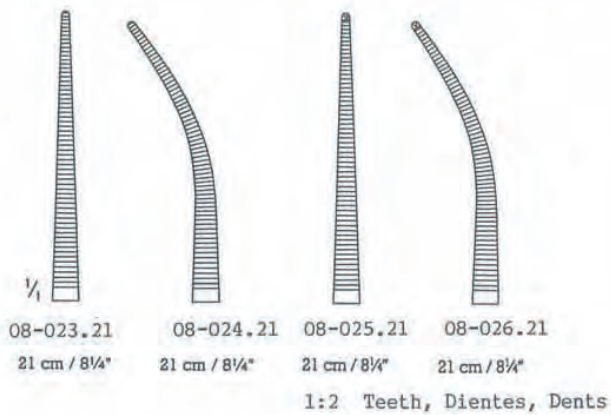
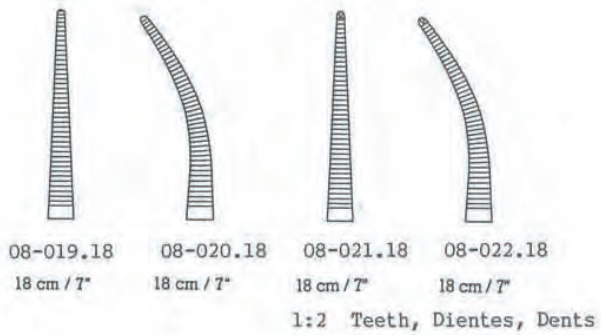

Micro-Mosquito

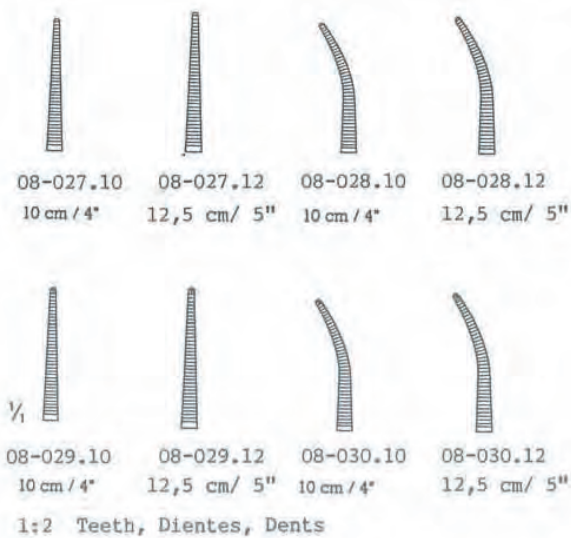

**KLEMMEN
FORCEPS**

Artery Forceps
Pinces hemostatiques
Pinzas hemostaticas

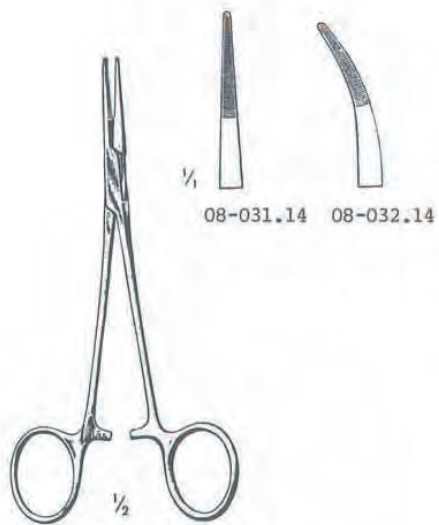

Providence-Hospital

14 cm / 5 1/2"

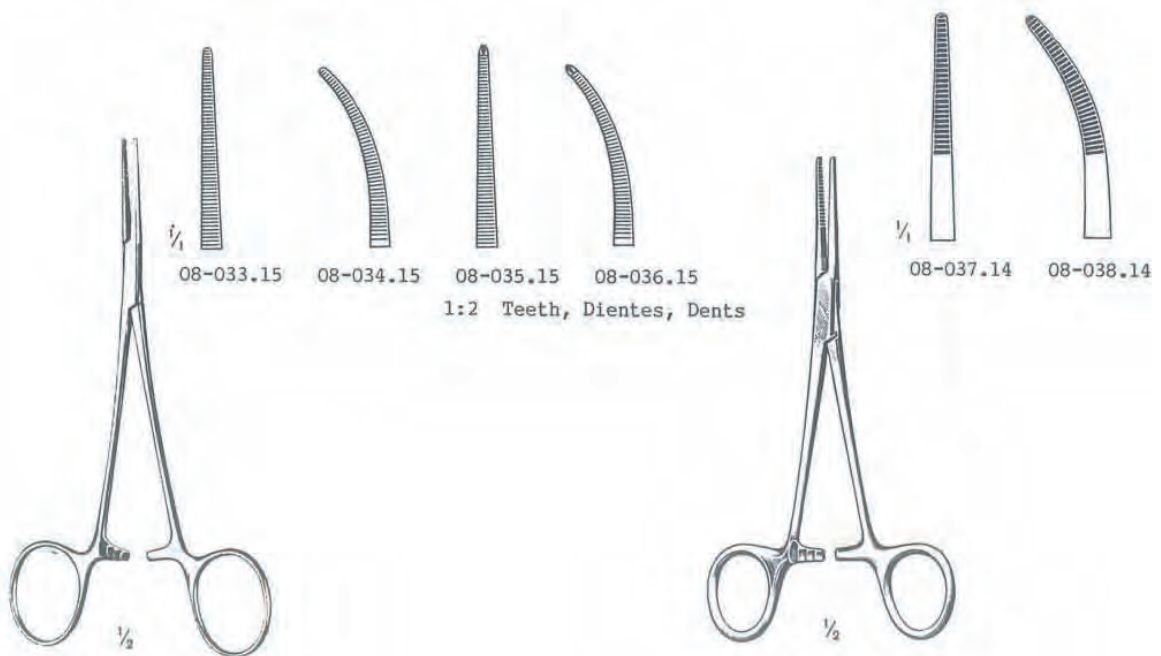

Leriche

15 cm / 8"

Kelly

14 cm / 5 1/2"

KLEMMEN FORCEPS

Artery Forceps
Pincas hemostatiques
Pinzas hemostaticas

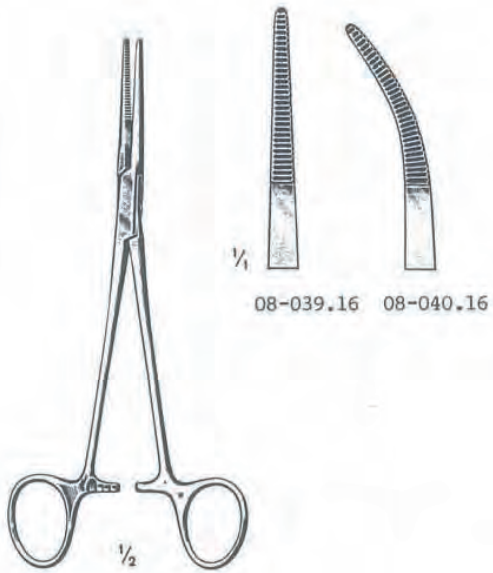

Kelly-Rankin

16 cm / 6 1/4"

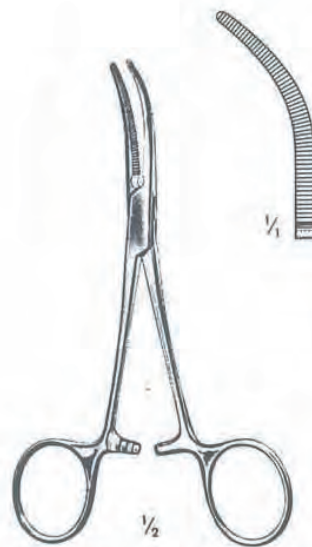

Baby-Overholt

08-041.14

13,5 cm / 5 1/4"

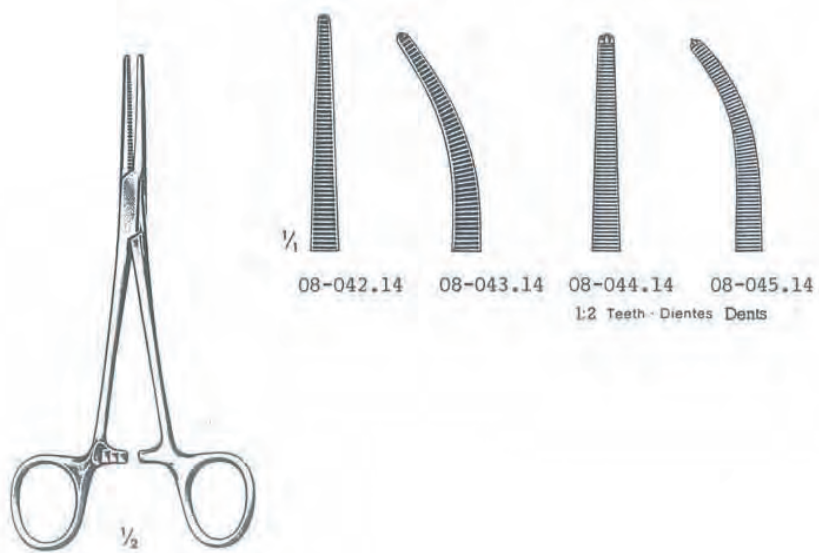

Crile

14 cm / 5 1/2"

1:2 Teeth - Dientes Dents

KLEMMEN FORCEPS

Artery Forceps
Pinces hemostatiques
Pinzas hemostaticas

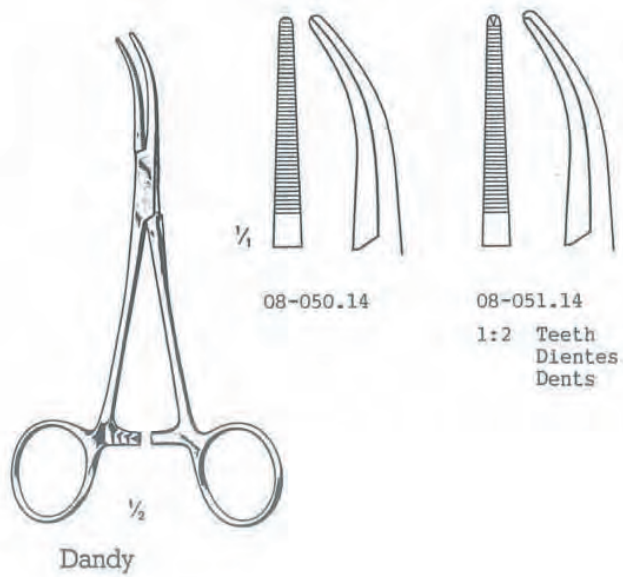
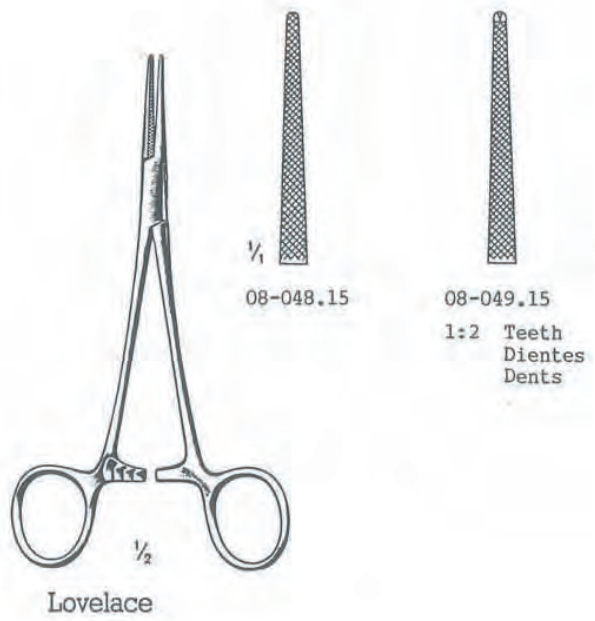
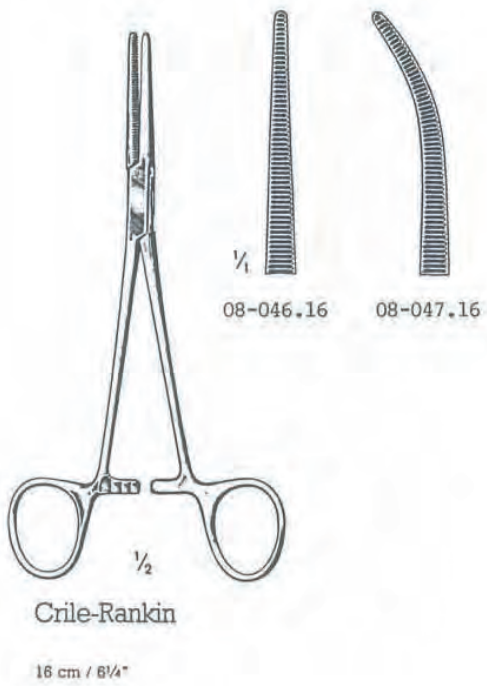

**KLEMMEN
FORCEPS**

Artery Forceps
Pincés hemostatiques
Pinzas hemostaticas

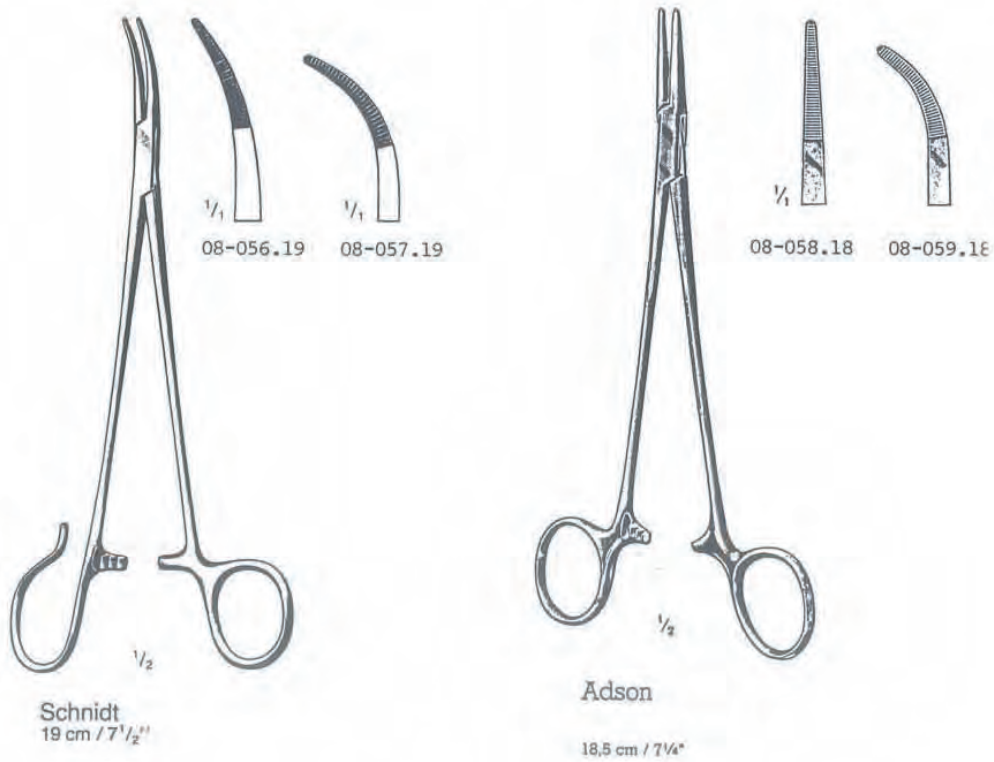
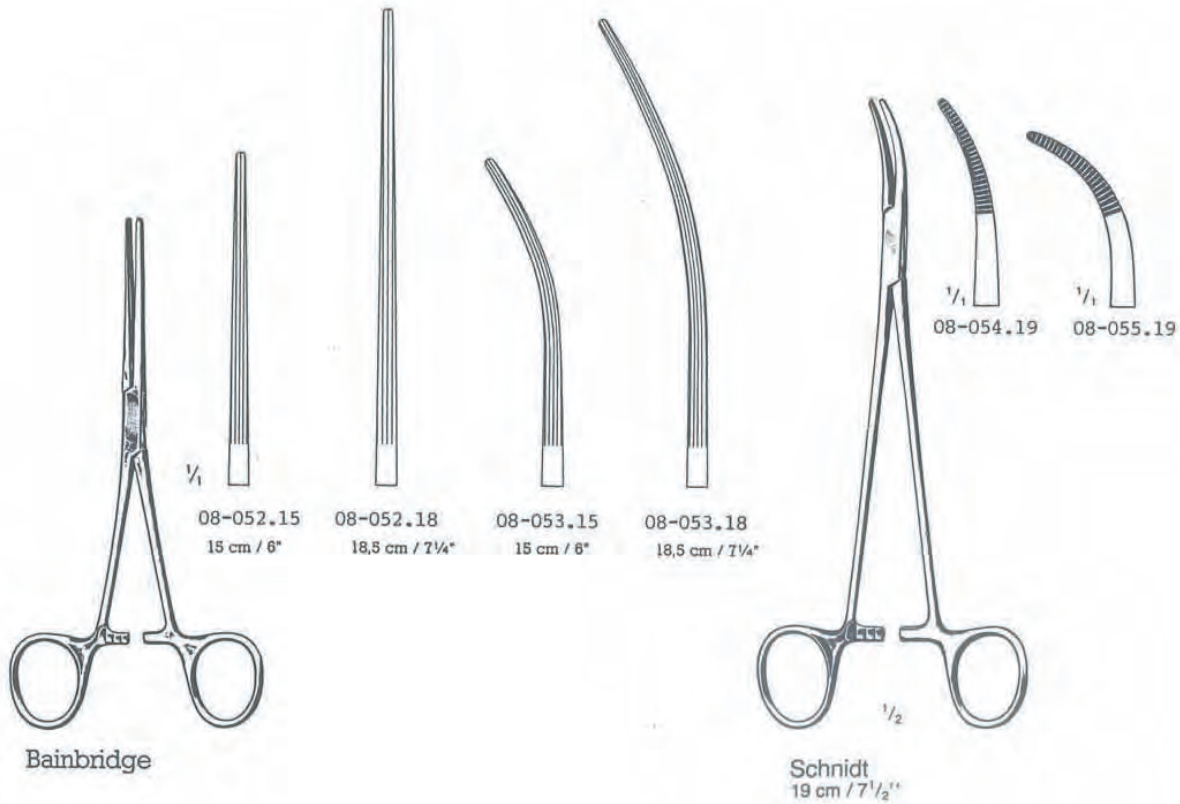

**KLEMMEN
FORCEPS**

Artery Forceps
Pinces hemostatiques
Pinzas hemostaticas



Adson

18,5 cm / 7 1/4"

1:2 Teeth, Dientes, Dents

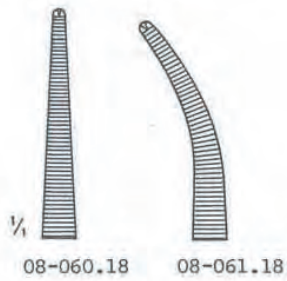

Rochester-Carmalt

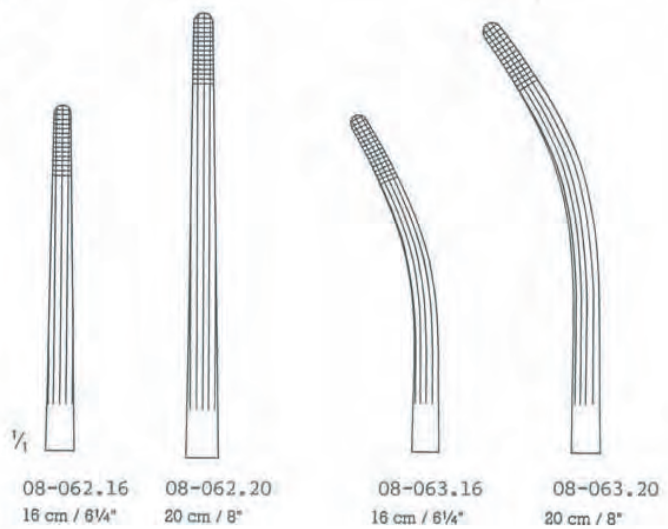

**KLEMMEN
FORCEPS**

Artery Forceps, Angiotribes
Pincas hemostaticas, pincas-clamps a pression progressive
Pinzas hemostaticas, pinzas-clamps de presion progresiva

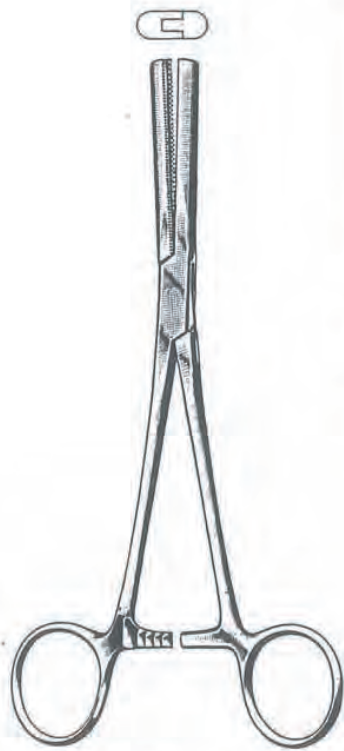

Fergusson

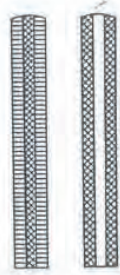

08-008.16
16 cm / 6 1/4"

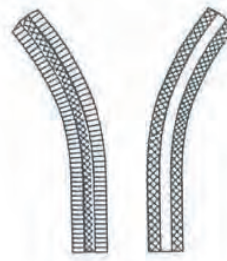

08-009.16
16 cm / 6 1/4"

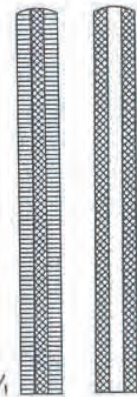

08-010.20
20 cm / 8"

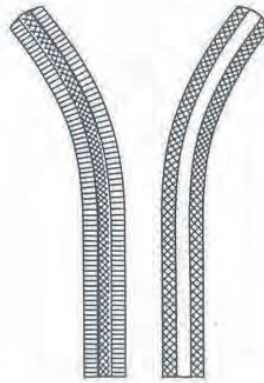

08-011.20
20 cm / 8"



Baby-Mixter
08-012.14



08-013.10



08-014.10



Hartmann

**KLEMMEN
FORCEPS**

Artery Forceps
Pincas hemostatiques
Pinzas hemostaticas



Bengolea

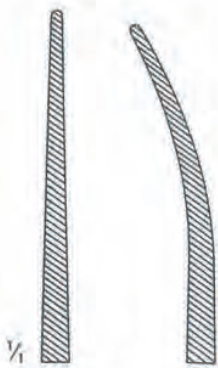

08-068.20
20 cm / 8"



08-069.20
20 cm / 8"



08-070.20
20 cm / 8"



08-071.20
20 cm / 8" 4"

1:2 Teeth, Dientes, Dents



08-072.26
26 cm / 8 1/4"



08-073.26
26 cm / 10 1/4"



08-074.26
26 cm / 10 1/4"



08-075.26
26 cm / 10 1/4"

1:2 Teeth, Dientes, Dents

**KLEMMEN
FORCEPS**

Artery Forceps
Pincés hemostatiques
Pinzas hemostaticas

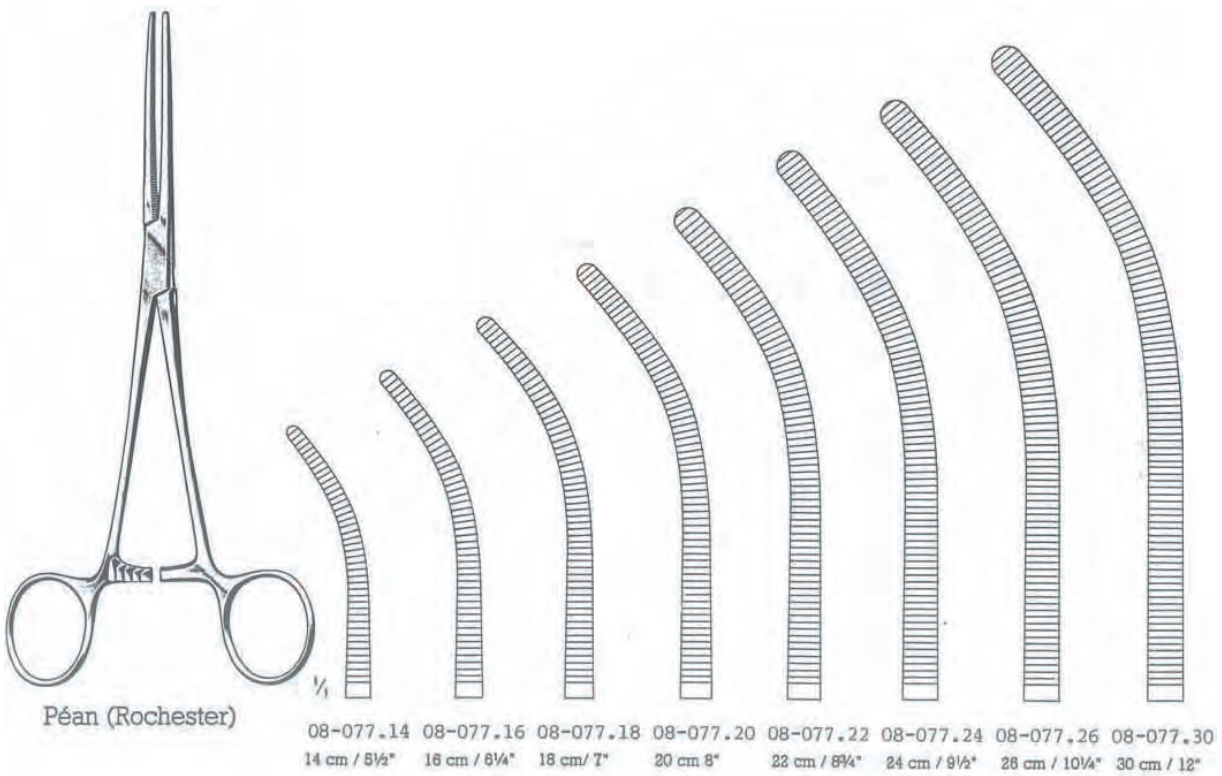
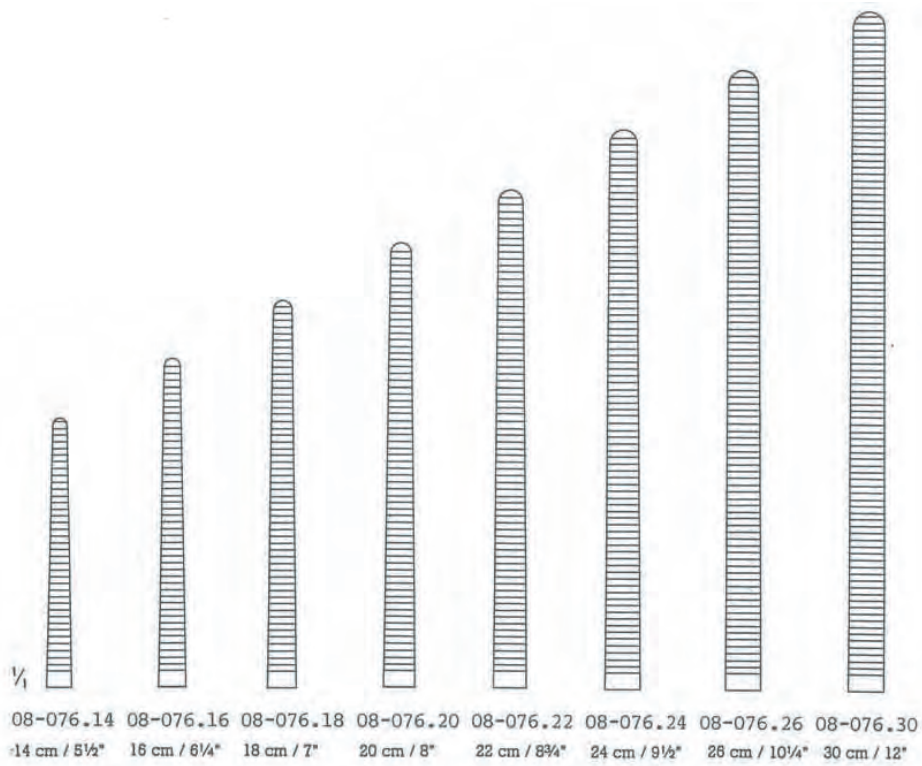

**KLEMMEN
FORCEPS**

Artery Forceps
Pinces hemostatiques
Pinzas hemostaticas

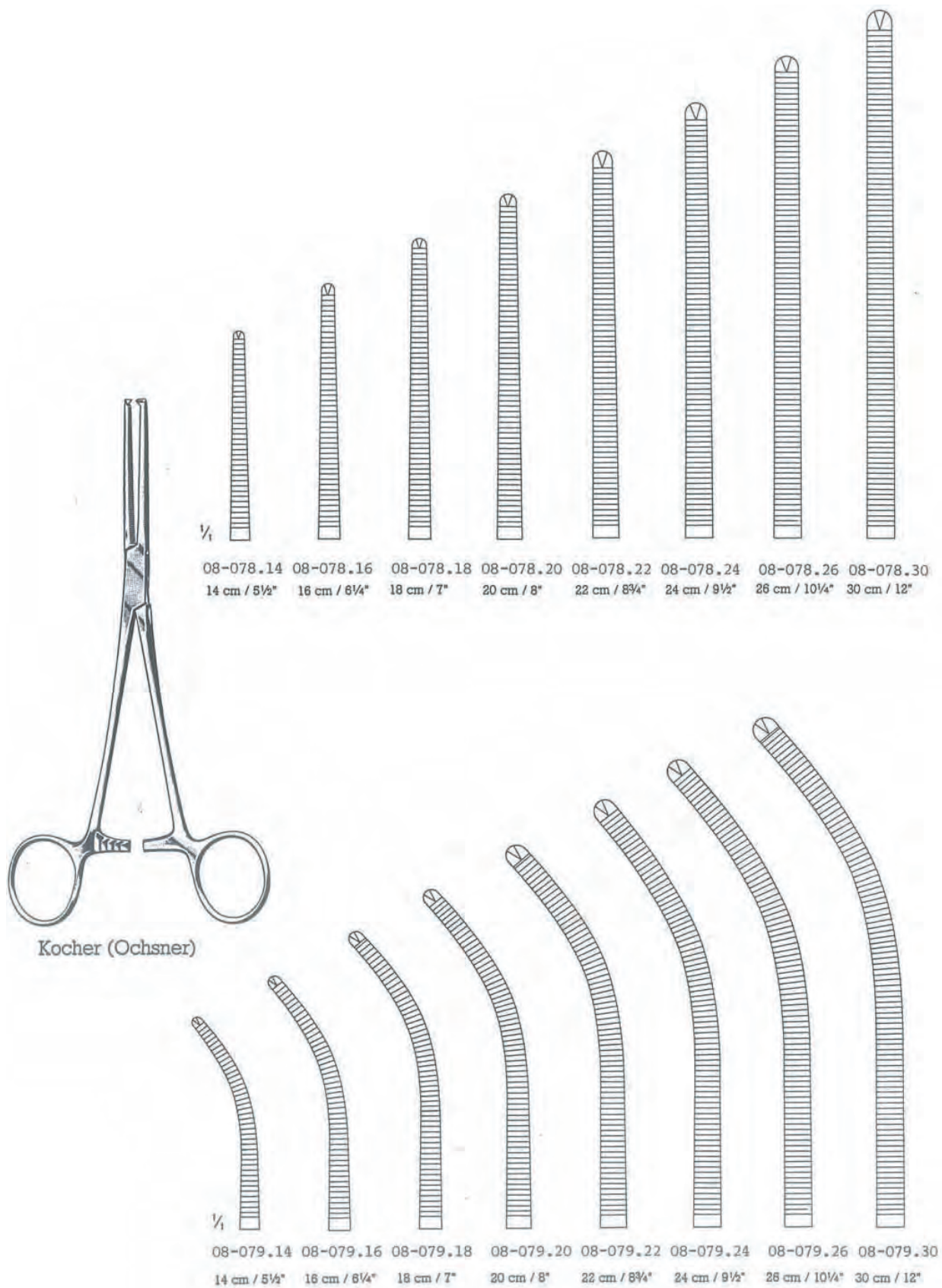

**KLEMMEN
FORCEPS**

Artery Forceps, Dissecting Forceps
Pincas hemostatiques, Pincas a Dissection
Pinzas hemostaticas, Pinzas para Preparaciones

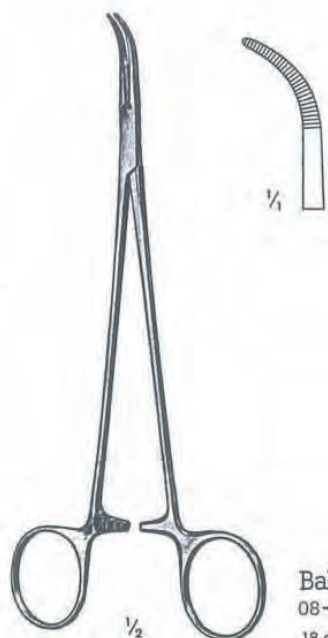

Baby-Mixer
08-080.18
18 cm / 7"

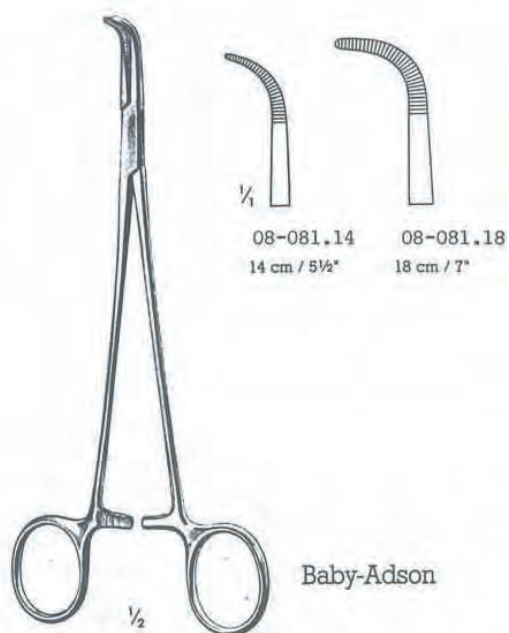

Baby-Adson



Heiss
20 cm / 8"



Overholt-Mixer
08-085.21
21 cm / 8 1/4"

**KLEMMEN
FORCEPS**

Artery Forceps, Dissecting Forceps
Pincés hemostáticos, Pincés a Dissection
Pinzas hemostáticas, Pinzas para Preparaciones

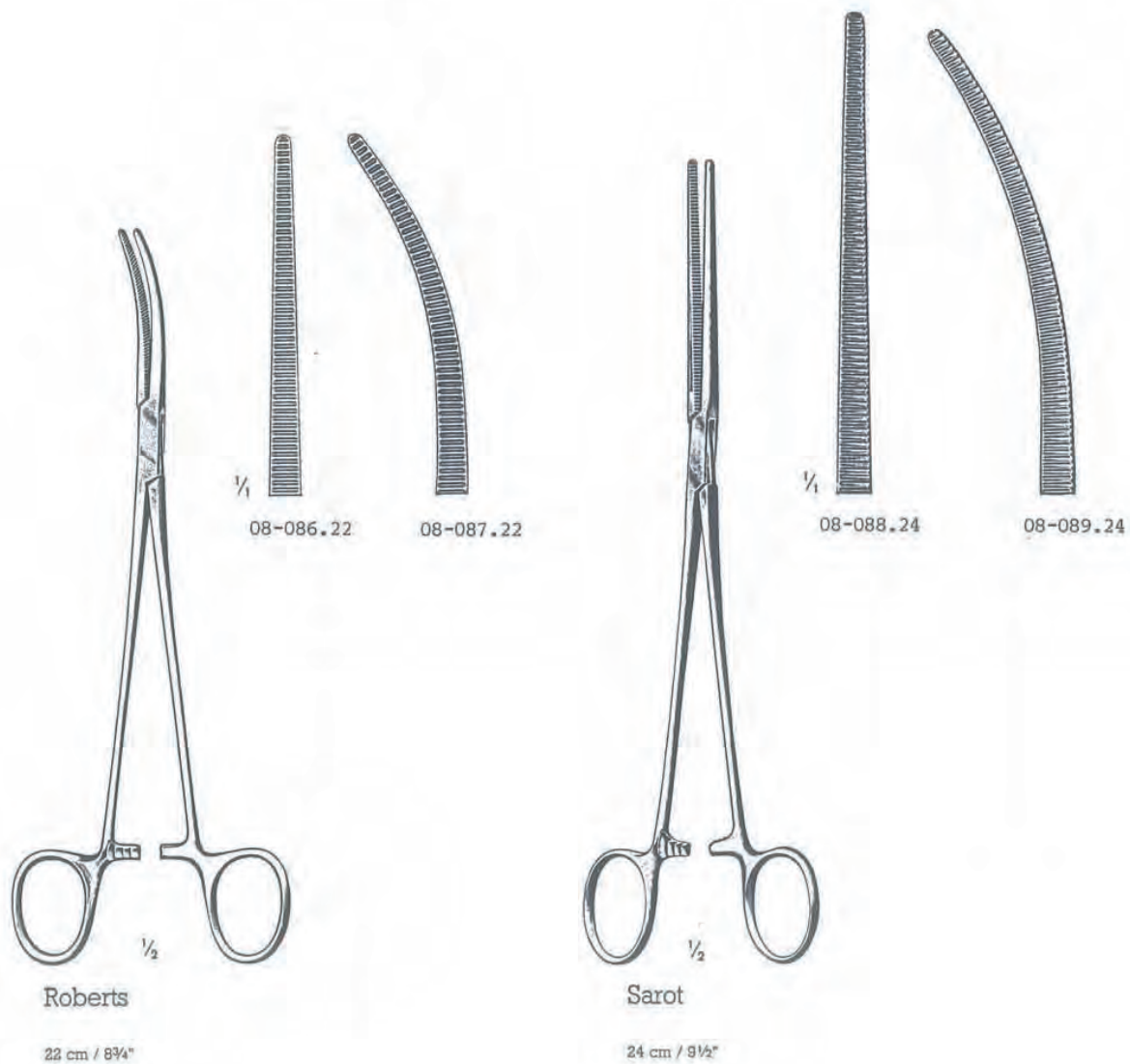

KLEMMEN FORCEPS

Artery Forceps, Dissecting Forceps
Pincés hemostáticos, Pincés a Dissection
Pinzas hemostáticas, Pinzas para Preparaciones

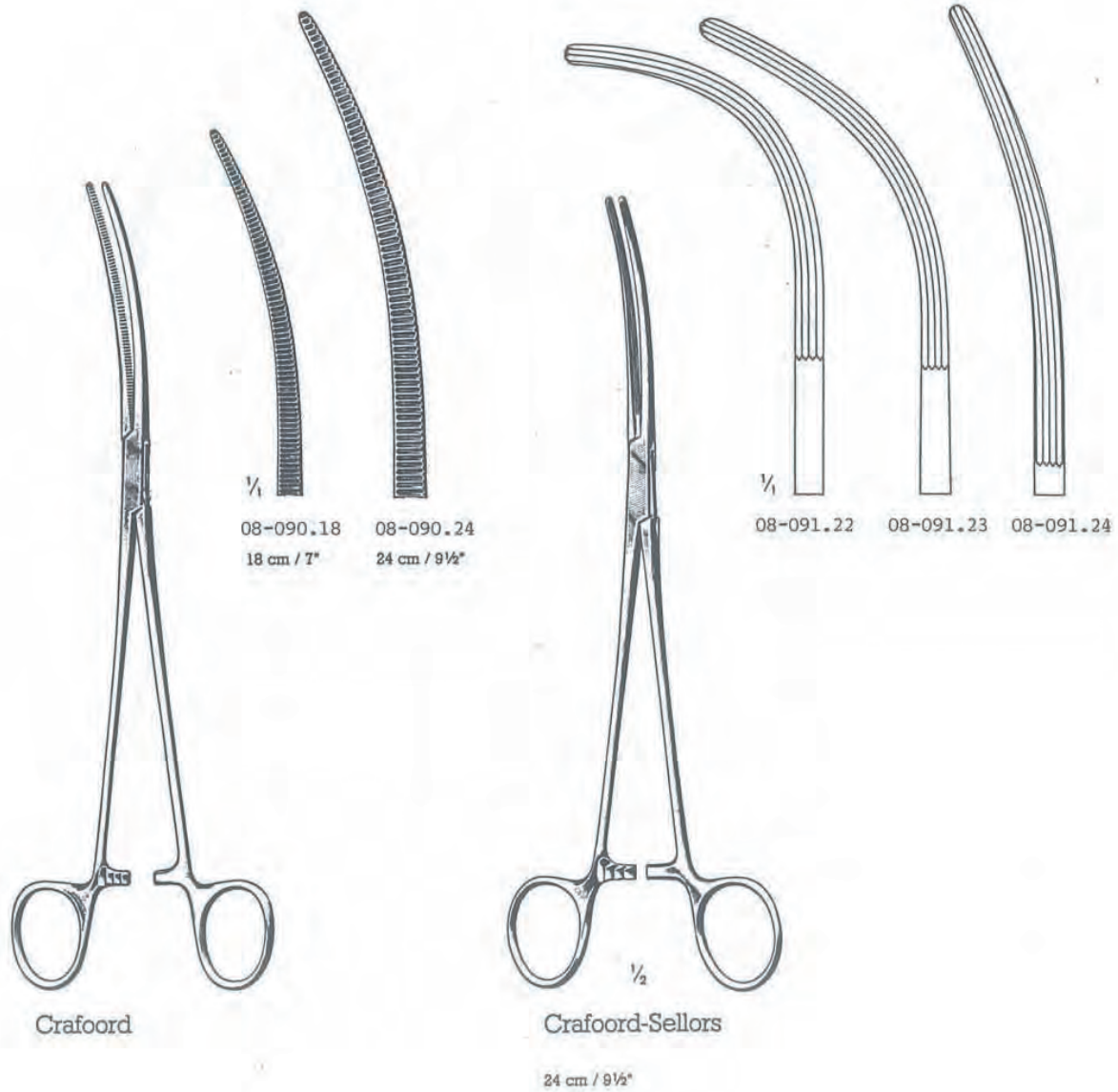

**KLEMMEN
FORCEPS**

Artery Forceps, Bronchus Forceps, Gall Duct Clamps
Pincés hemostatiques, Pincés bronchiques, Pincés Clamp pour voies biliares
Pinzas hemostaticas, Pinzas para bronquios, Pinzas-Clamps para conductos biliares

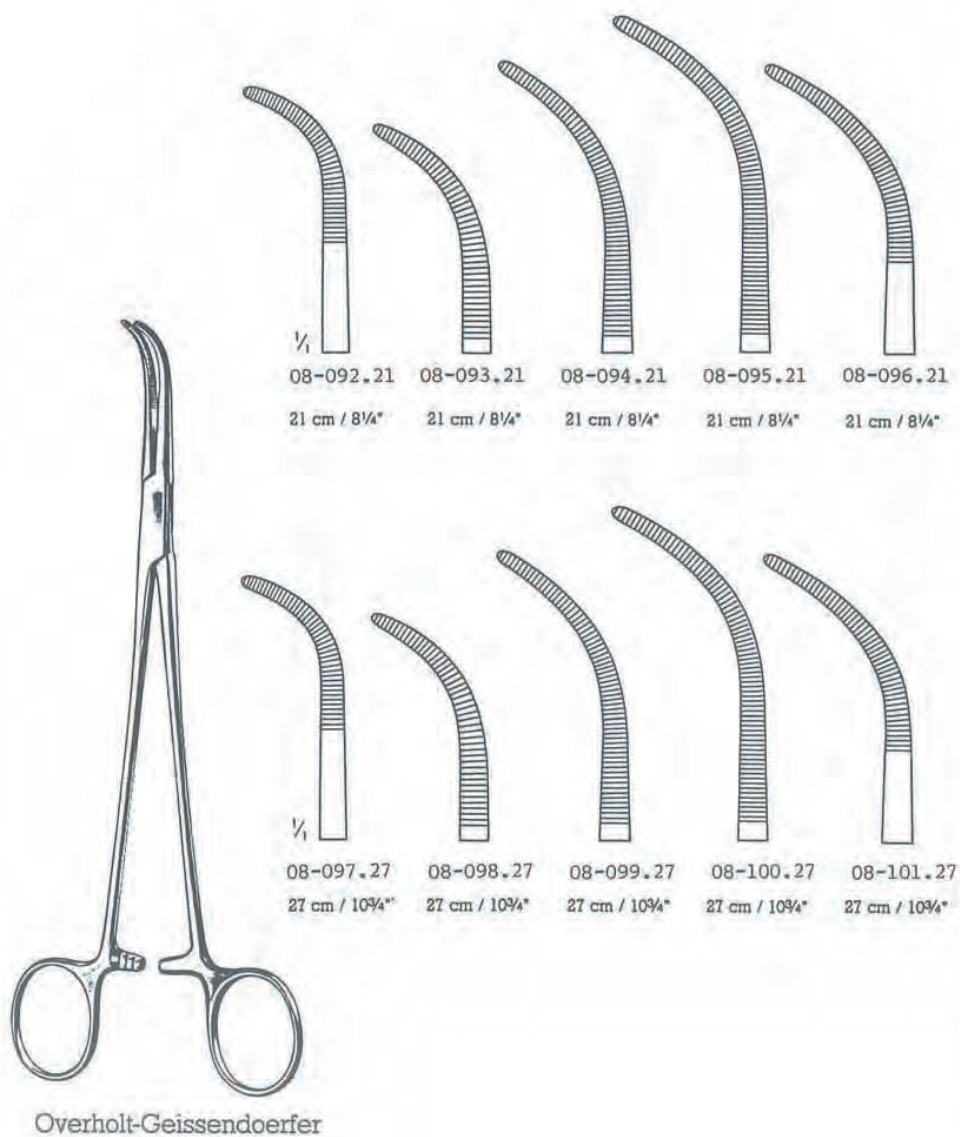

KLEMMEN FORCEPS

Artery Forceps, Bronchus Forceps
Pincés hemostatiques, Pincés bronchiques
Pinzas hemostaticas, Pinzas para bronquios

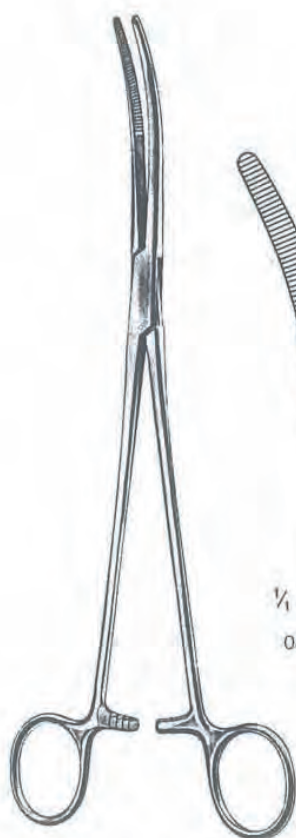

Rumel

23 cm / 9"



08-104.23



08-105.23



08-106.23



08-107.23



08-108.23

**KLEMMEN
FORCEPS**

Artery Forceps
Pincas hemostatiques
Pinzas hemostaticas



Toennis

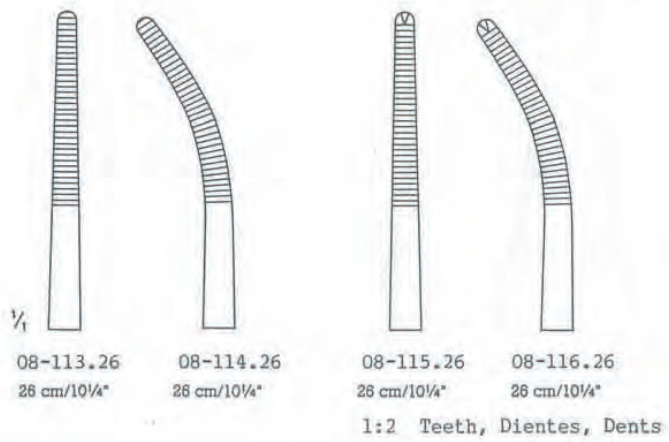
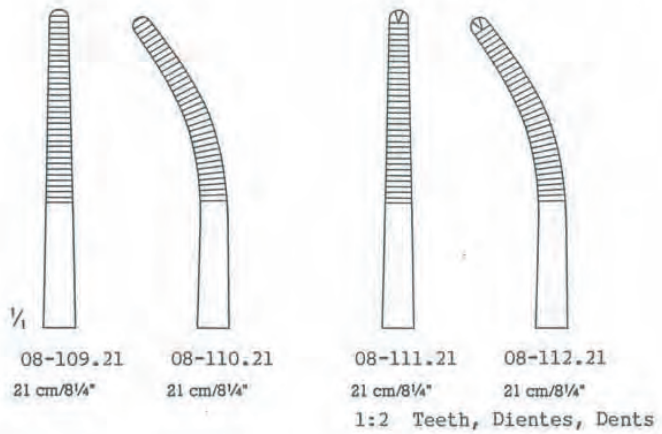

**KLEMMEN
FORCEPS**

Artery Forceps, Dissecting Forceps
Pincés hemostáticos, Pincés a Dissection
Pinzas hemostáticas, Pinzas para Preparaciones

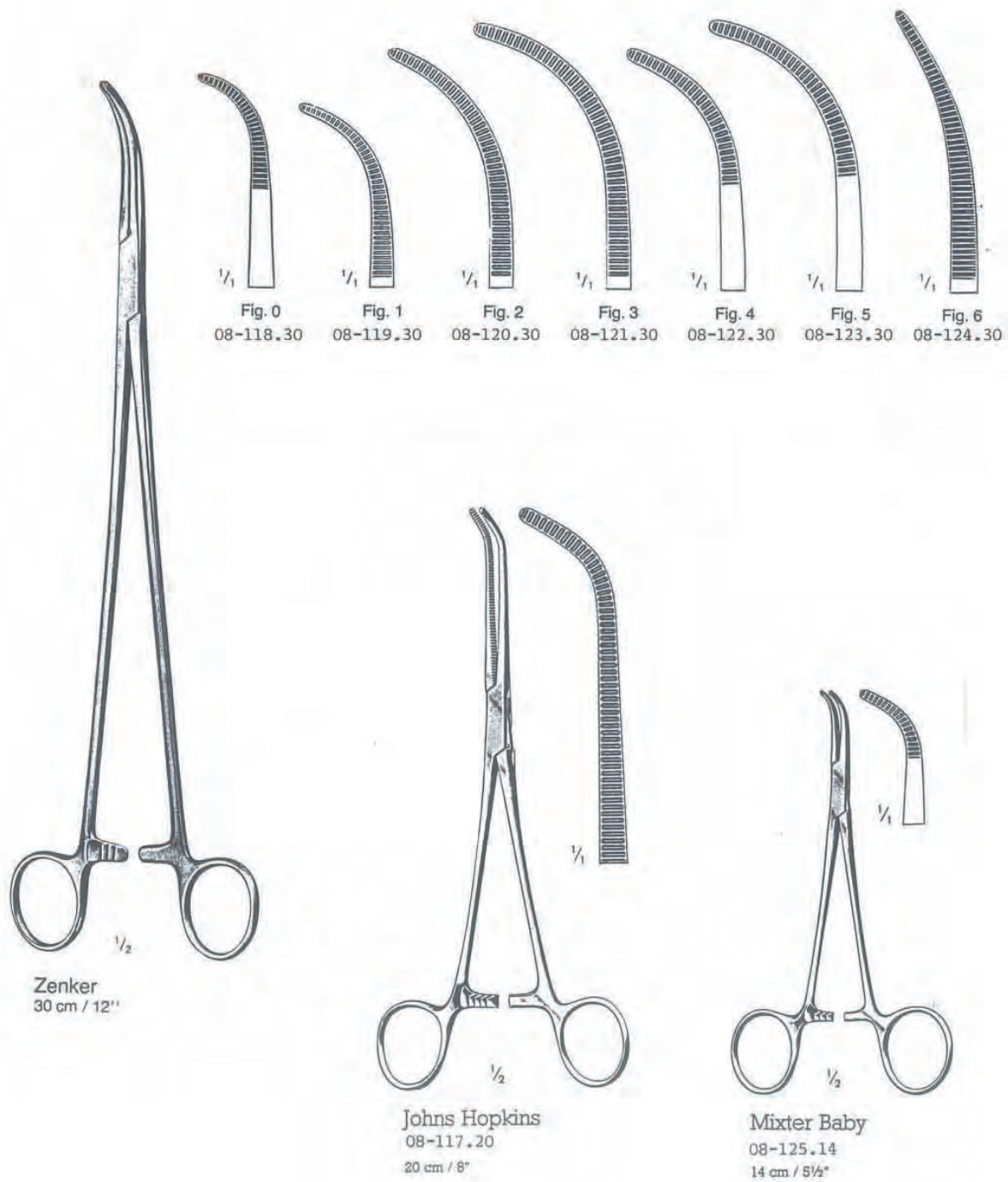

**KLEMMEN
FORCEPS**

Artery Forceps, Bronchus Forceps, Gall Duct Clamps
Pincés hemostatiques, Pincés bronchiques, Pincés Clamp pour voies biliares
Pinzas hemostaticas, Pinzas para bronquios, Pinzas-Clamps para conductos biliares

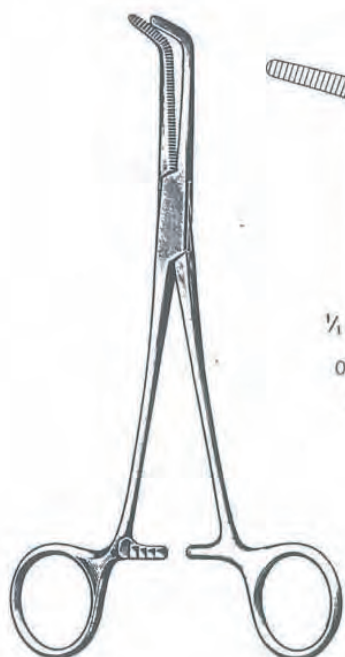

Mixer

08-126.15 08-126.19
16 cm / 6¼" 18 cm / 7"

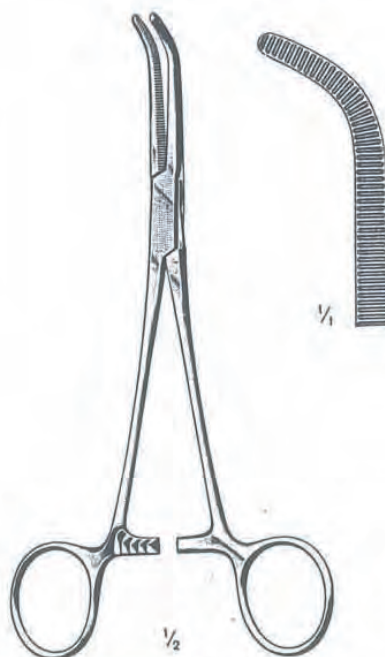

Mixer-O'Shaugnessy
08-127.19
19 cm / 7½"

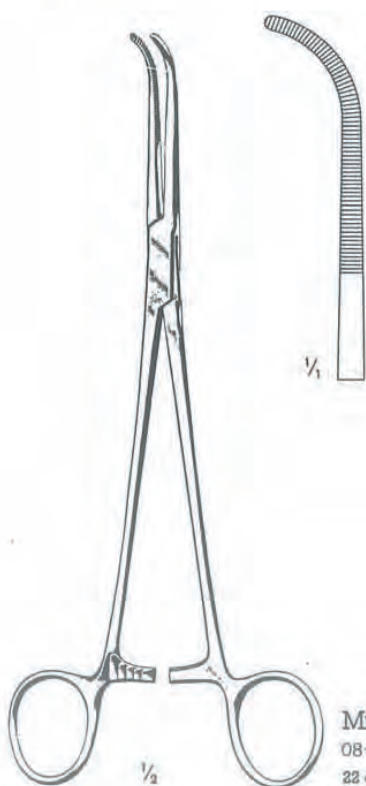

Mixer
08-128.22
22 cm / 8¾"



Mixer
08-129.23
23 cm / 9"

**KLEMMEN
FORCEPS**

Artery Forceps, Bronchus Forceps
Pincés hemostatiques, Pincés bronchiques
Pinzas hemostaticas, Pinzas para bronquios



**KLEMMEN
FORCEPS**

Artery Forceps, Bronchus Forceps
Pincés hemostáticas, Pincés bronquiales
Pinzas hemostáticas, Pinzas para bronquios

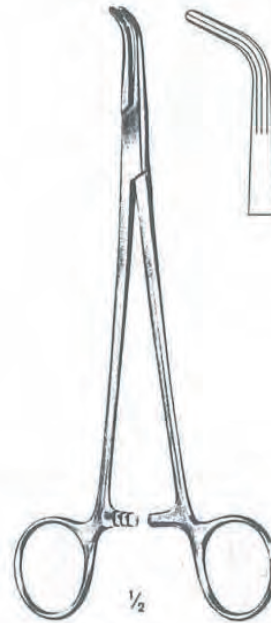

Lower
08-131.18
18 cm / 7"



Lahey

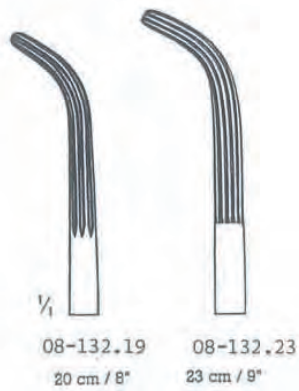

08-132.19
20 cm / 8"

08-132.23
23 cm / 9"

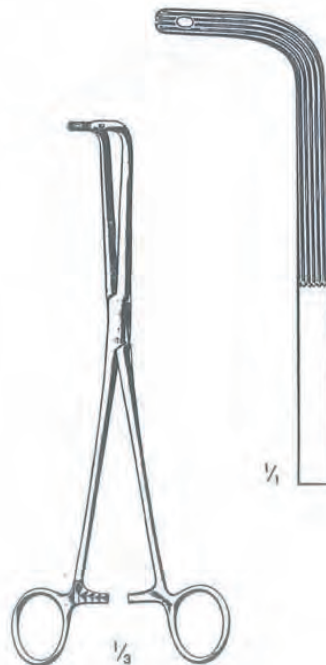

Finocchietto
08-133.24
24 cm / 9 1/2"

KLEMMEN FORCEPS

Kidney Pedicle Clamps
Pinces-Clamps pour pedicules renaux
Pinzas-Clamps para pedunculos renales

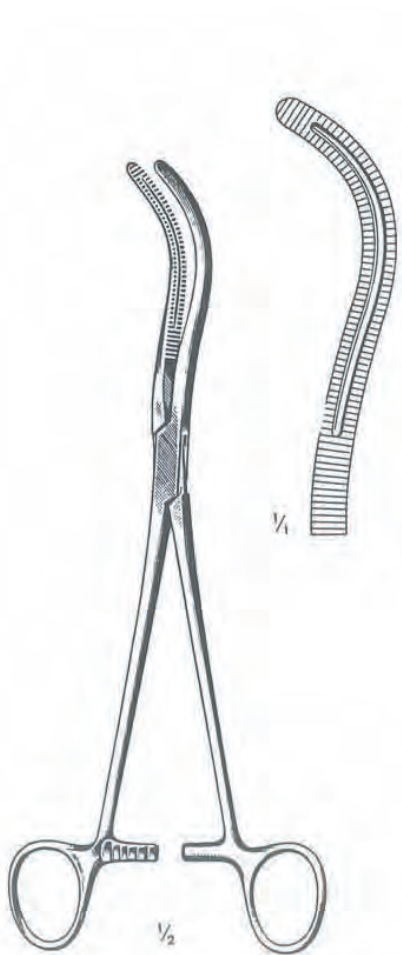

Stille
08-134.24
23 cm / 9"



Herrick
08-135.23
23 cm / 9"

**KLEMMEN
FORCEPS**

Gall Duct Clamps
Pincés-Clamps pour voies biliaires
Pinzas-Clamps para conductos biliares

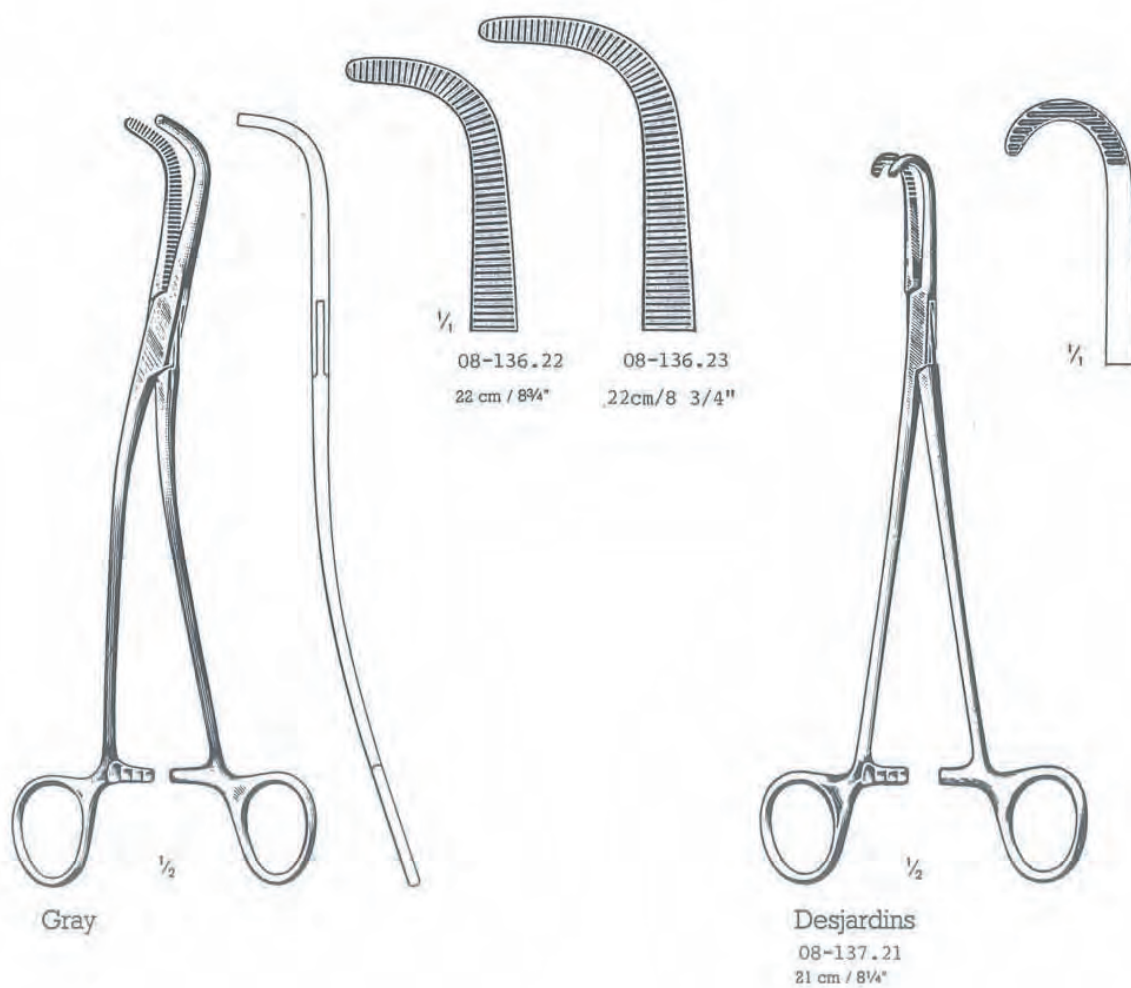

KLEMMEN FORCEPS

Kidney Pedicle Clamps
Pinces-Clamps pour pedicules renaux
Pinzas-Clamps para pedunculos renales

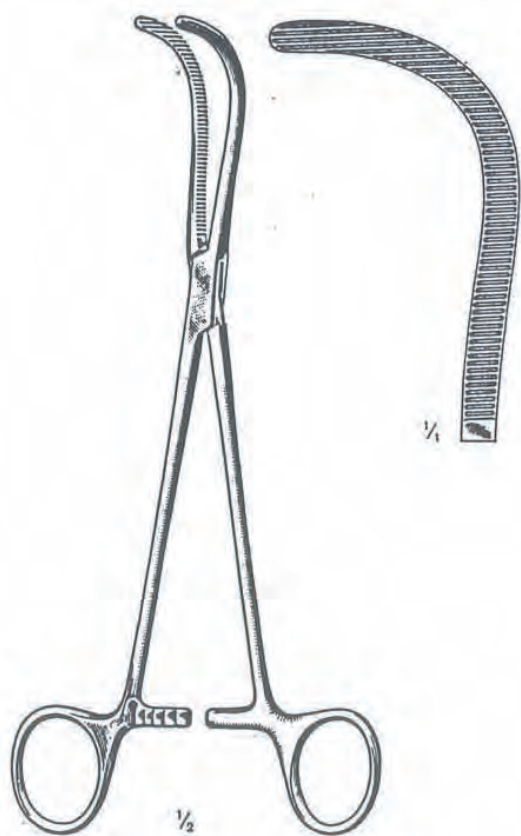

Guyon
08-138.23
23 cm / 9"

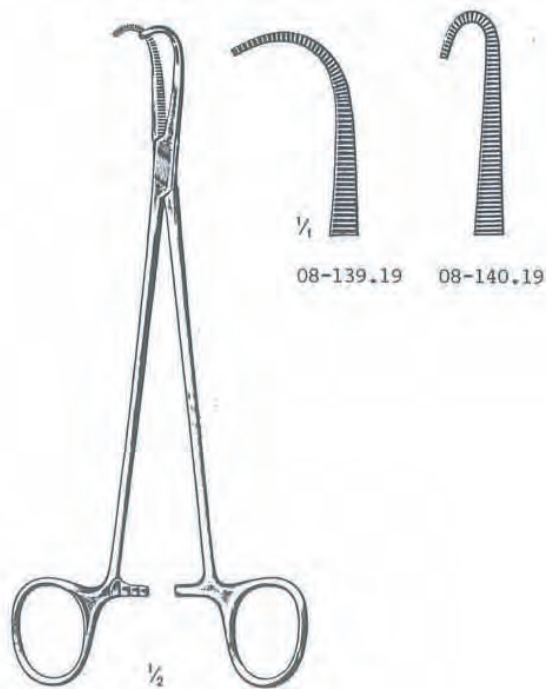

Negus
19 cm / 7 1/2"

**KLEMMEN
FORCEPS**

Clamp-Forceps, Hysterectomy Forceps
Pincers-Clamps, Pincers a hysterectomie
Pinzas-Clamps, Pinzas para Histerectomia

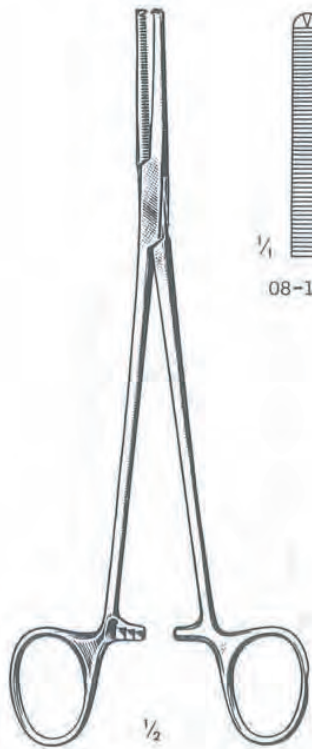

Phaneuf

21 cm / 8 1/2"

1:2 Teeth, Dientes, Dents



08-141.21



08-142.21



08-143.21

20 cm / 8"



08-143.23

23cm/9"



08-144.21

20 cm 8"



08-144.23

23cm/9"

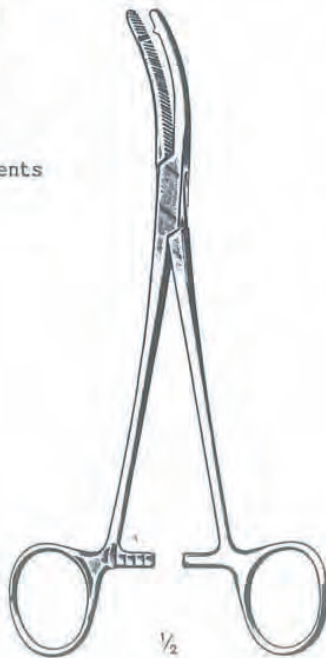

Heaney

**KLEMMEN
FORCEPS**

Clamp-Forceps, Hysterectomy Forceps
Pincés-Clamps, Pincés a hysterectomie
Pinzas-Clamps, Pinzas para Histerectomia

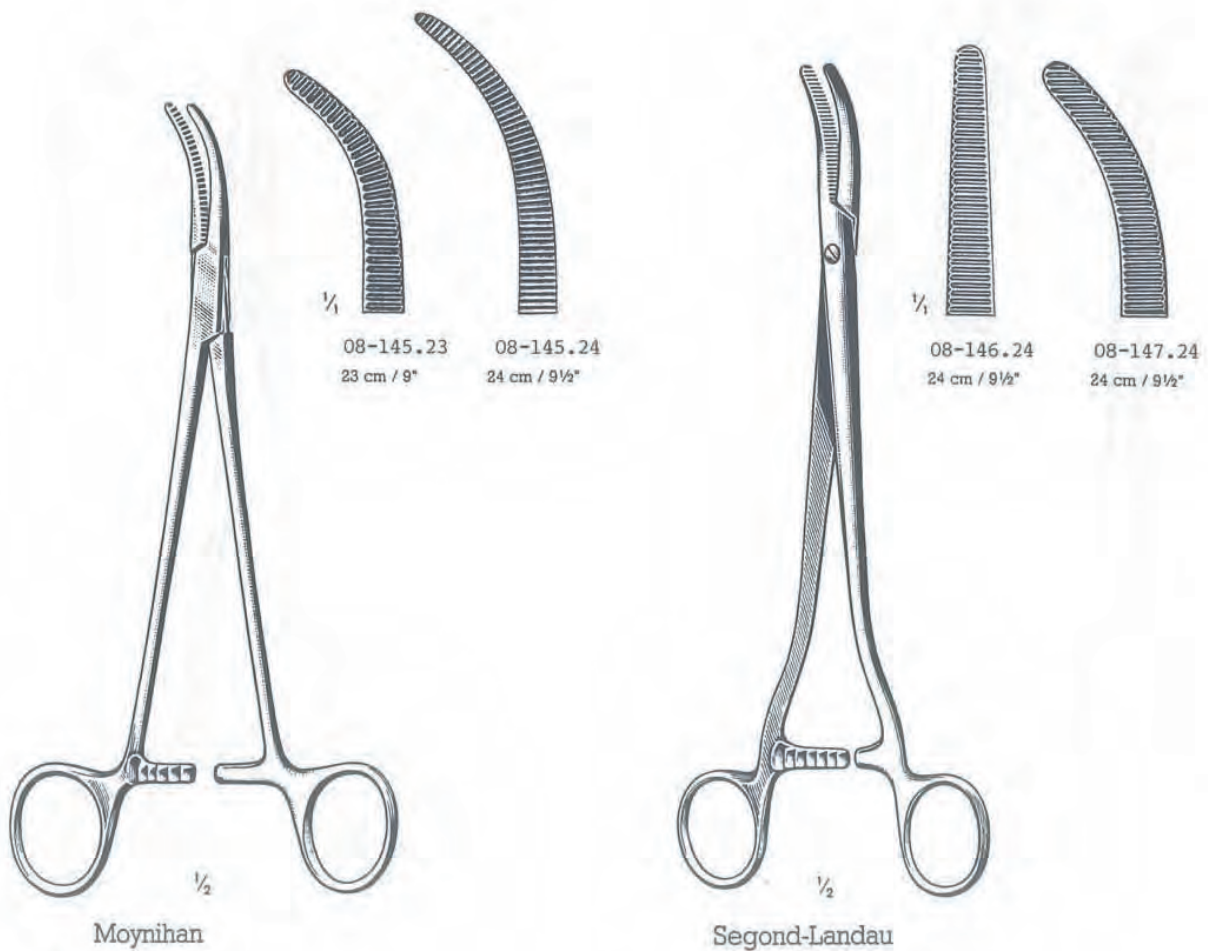

**KLEMMEN
FORCEPS**

Clamp-Forceps, Hysterectomy Forceps
Pinces-Clamps, Pincas a hysterectomie
Pinzas-Clamps, Pinzas para Histerectomia

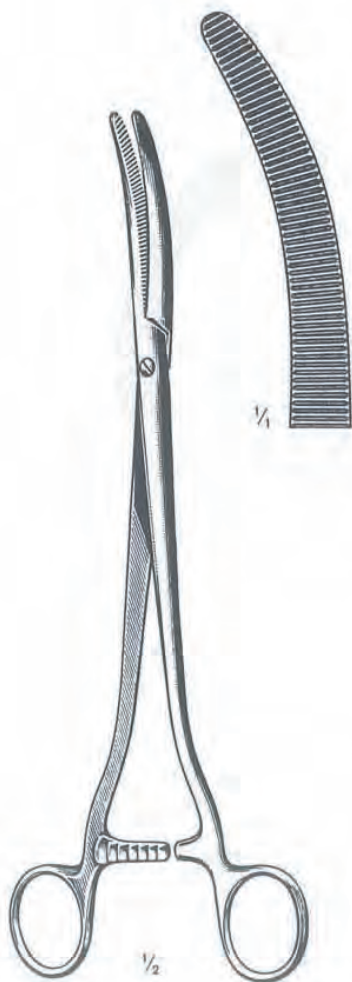

Faure
08-148.25
25 cm / 10"

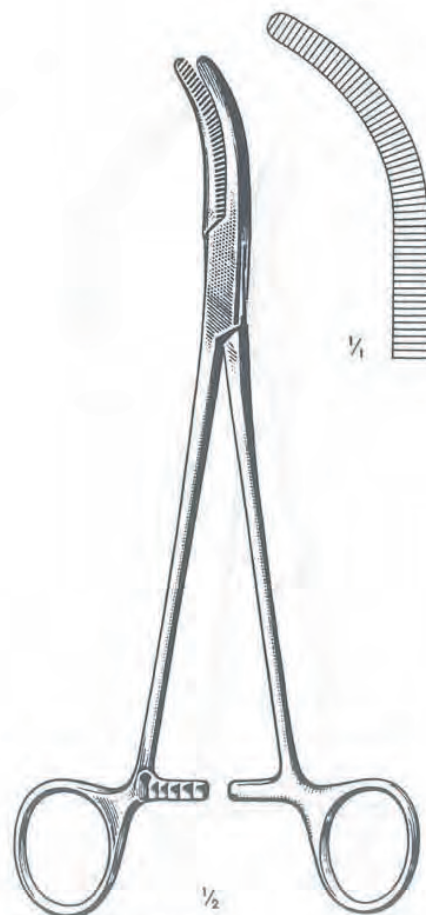

Wertheim
08-150.25
25 cm / 10"

**KLEMMEN
FORCEPS**

Clamp-Forceps, Hysterectomy Forceps
Pincas-Clamps, Pincas a hysterectomie
Pinzas-Clamps, Pinzas para Histerectomia

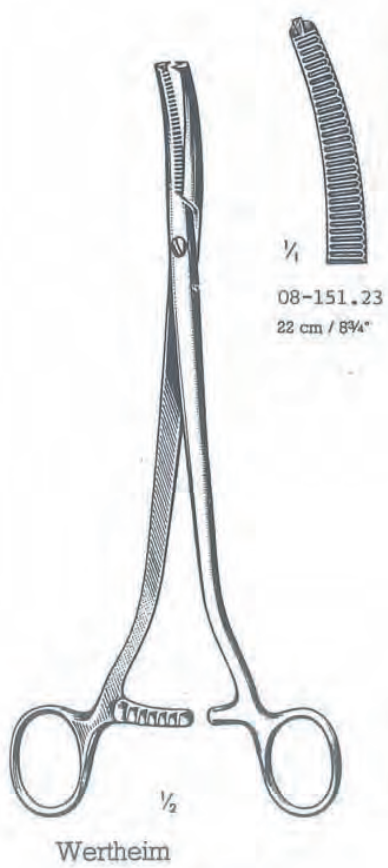

1:2 Teeth, Dientes, Dents

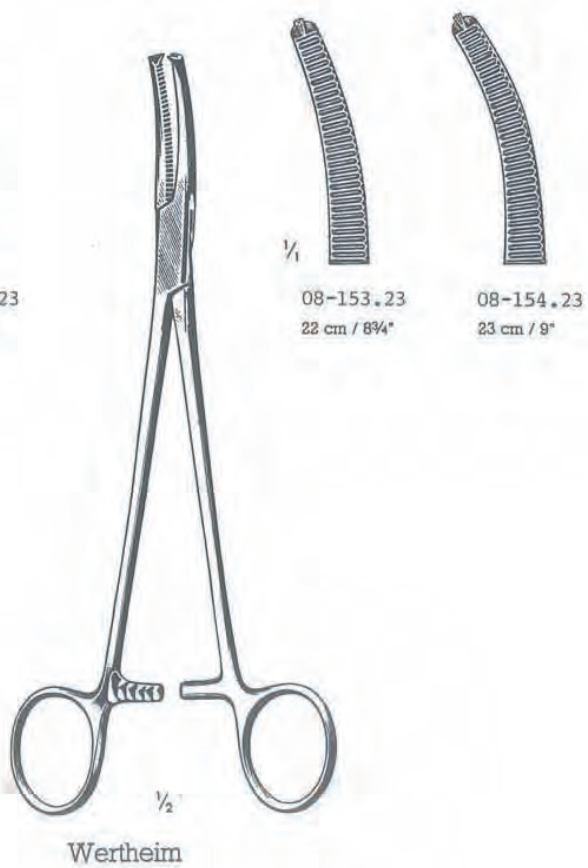

1:2 Teeth, Dientes, Dents

**KLEMMEN
FORCEPS**

Peritoneal Clamp Forceps
Pinces-Clamp pour le Peritoine
Pinzas-Clamps para Peritoneo

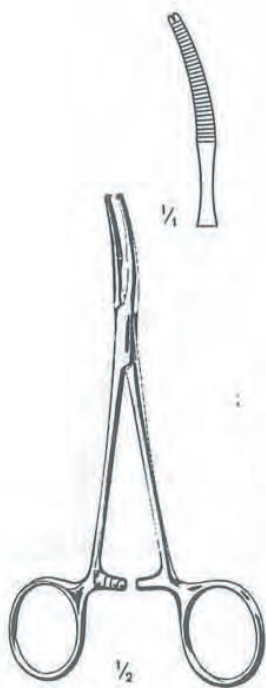

Baby-Mikulicz
08-155.14
14 cm / 5½"

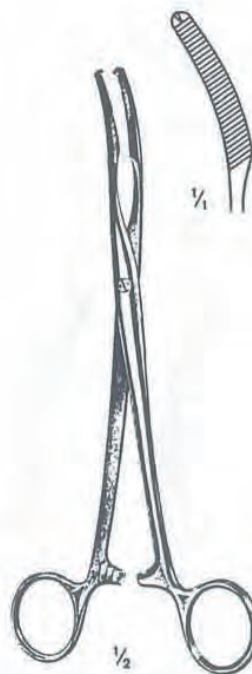

Mikulicz
08-156.18
18 cm / 7"

**KLEMMEN
FORCEPS**

Peritoneal Clamp Forceps
Pinces-Clamp pour le Peritoine
Pinzas-Clamps para Peritoneo

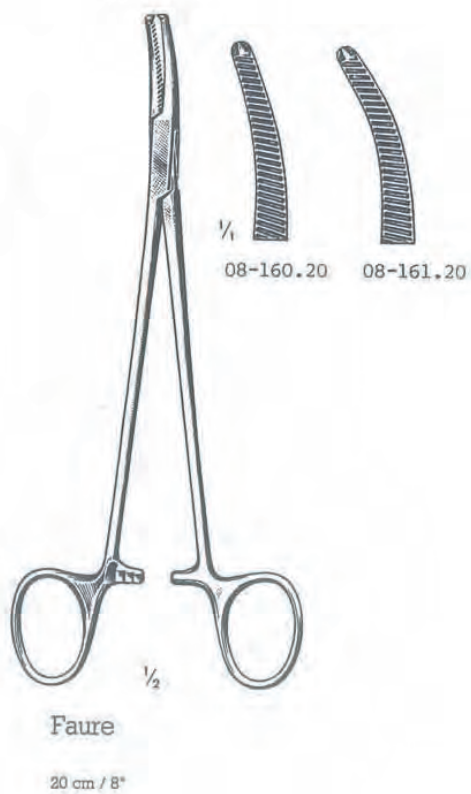
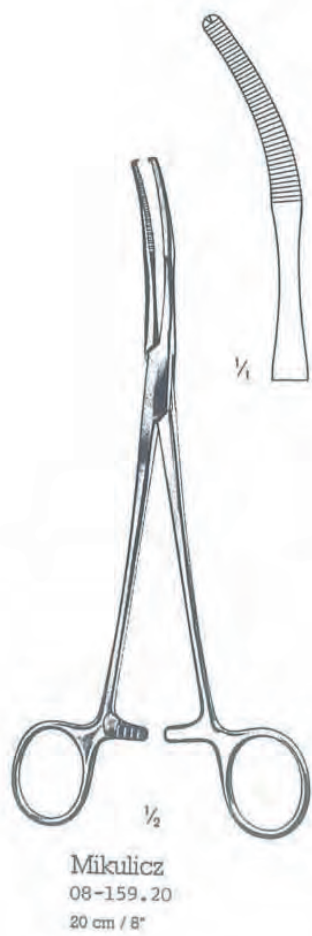
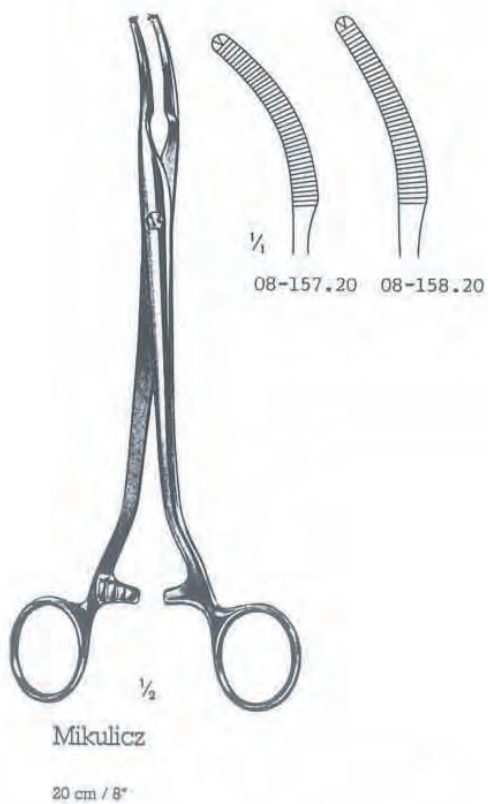

**KLEMMEN
FORCEPS**

Towel Forceps
Pinzas a Compresses
Pinzas para Compresas



1/2

Schaedel
08-162.09
9 cm / 3 1/2"

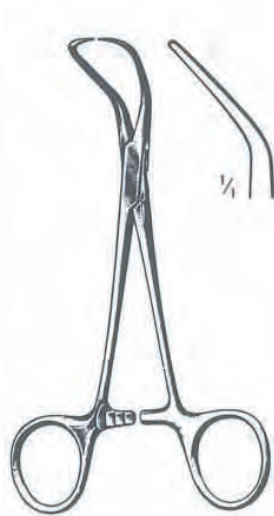

1/4

Backhaus

08-163.08 = 8 cm / 3 1/4"
08-163.11 = 11 cm / 4 1/2"
08-163.13 = 13 cm / 5"
08-163.15 = 15 cm / 6"

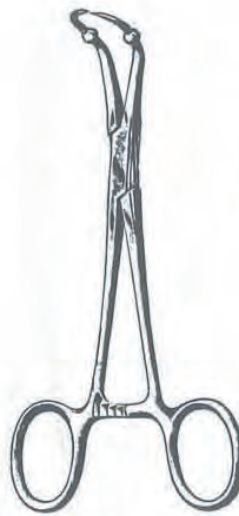

Roeder

08-164.13 = 13 cm / 5"

**KLEMMEN
FORCEPS**

Towel Forceps
Pinzas a Compresses
Pinzas para Compresas



1/2
Bernhard
08-166.16
16 cm / 6 1/2"

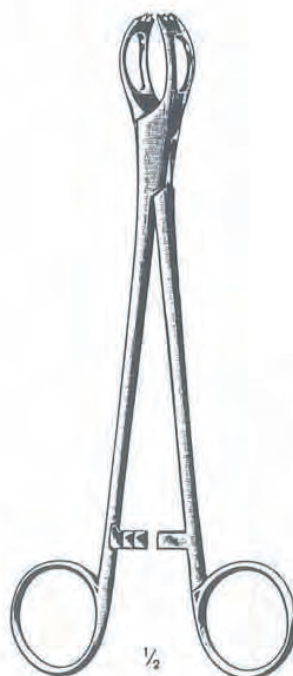

1/2
Lane
08-167.20
20cm/8"

**KLEMMEN
FORCEPS**

Dressing and Cotton Swab Forceps
Pincés a Pansements et Tampons
Pinzas para Vendajes y Tapones

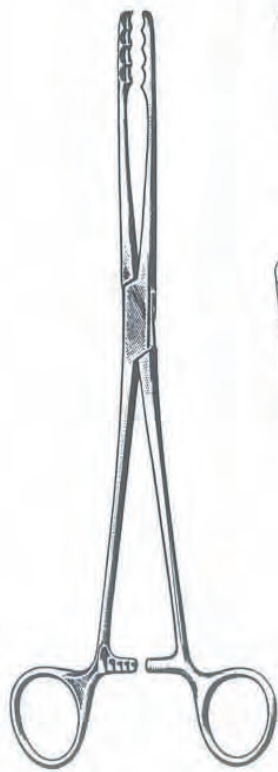
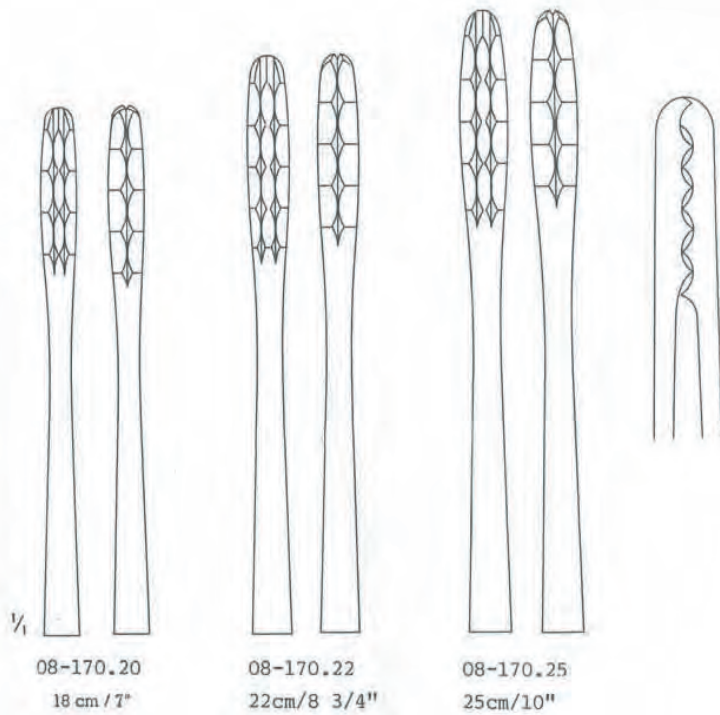

Ulrich

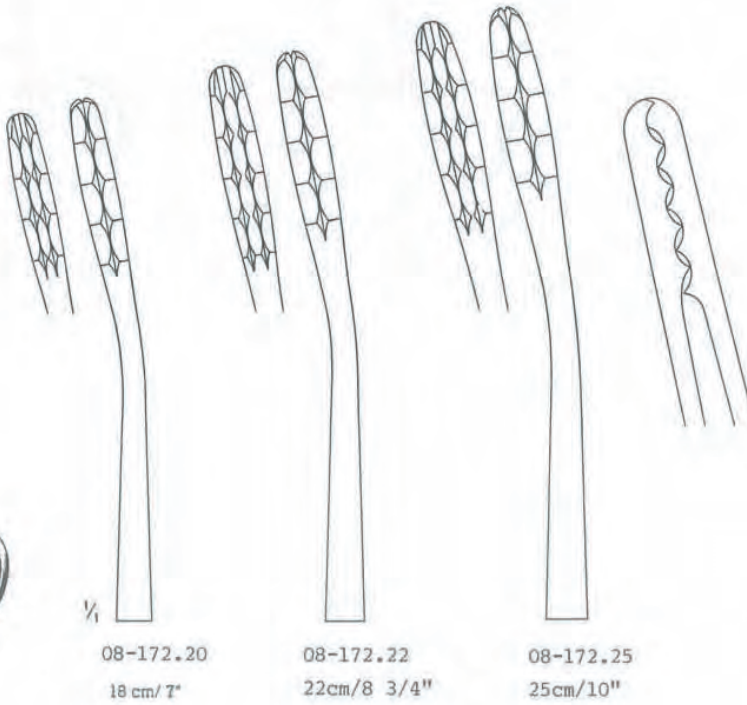

KLEMMEN FORCEPS

Dressing and Cotton Swab Forceps
Pincas a Pansements et Tampons
Pinzas para Vendajes y Tapones

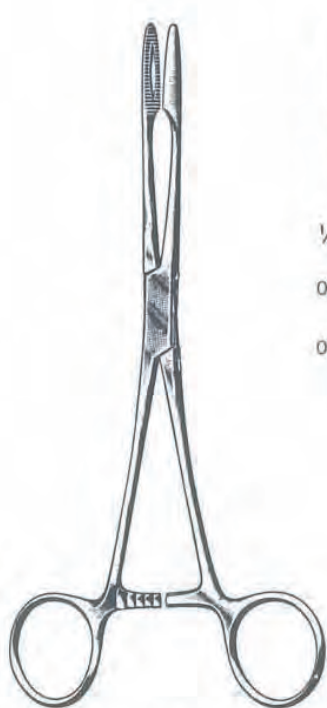

Maier



08-179.20 = 20 cm / 8"

08-179.25 = 25 cm / 10"

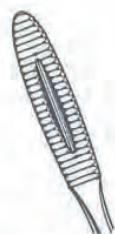

08-180.20 = 20 cm / 8"

08-180.25 = 25 cm / 10"

**KLEMMEN
FORCEPS**

Polypus and Dressing Forceps, Cotton Swab Forceps
Pincés a Pansements et Polypes, Pincés a Tampones
Pinzas para Polipos y Vendajes, Pinzas para Tapones

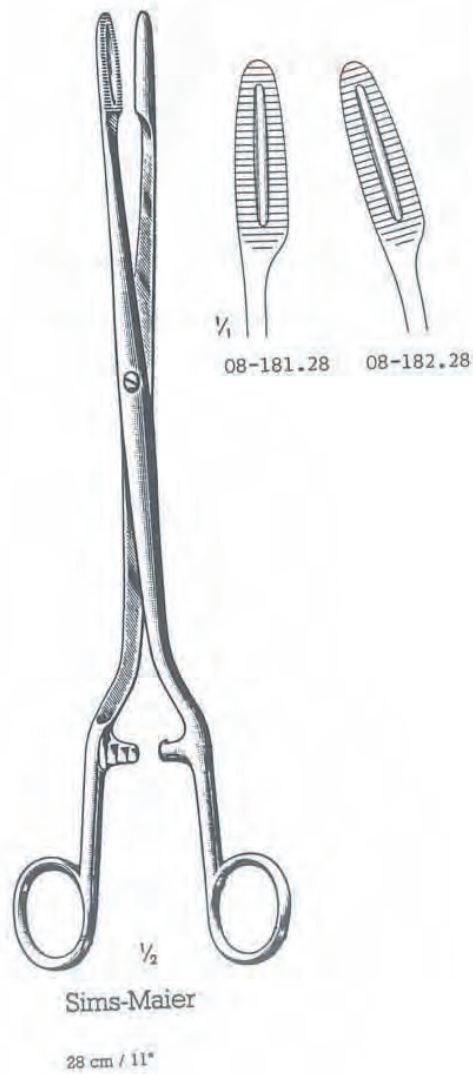

**KLEMMEN
 FORCEPS**

Polypus and Dressing Forceps, Cotton Swab Forceps
 Pincas a Pansements et Polypes, Pincas a Tampones
 Pinzas para Polipos y Vendajes, Pinzas para Tapones



**KLEMMEN
FORCEPS**

Cotton Swab Forceps, Sponge Holding Forceps
Pinces a Tampones et Esponges
Pinzas para Tapones, Pinzas Porta-Esponjas

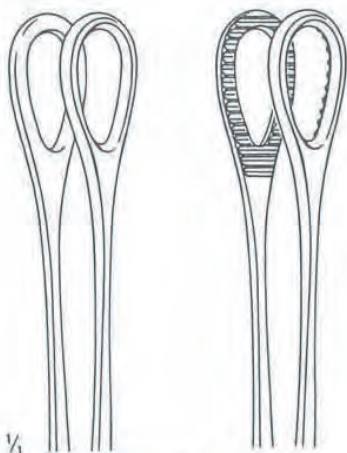

08-190.18=18cm/7" 08-191.18 = 18 cm / 7"
08-190.20=20cm/8" 08-191.20 = 20 cm / 8"
08-190.25=25cm/10" 08-191.25 = 25 cm / 10"

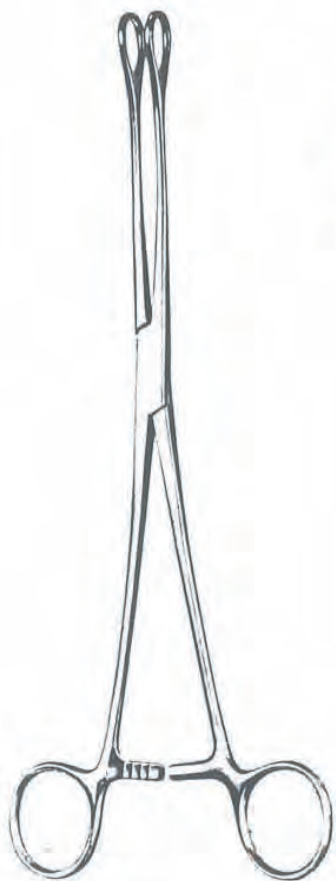

Foerster

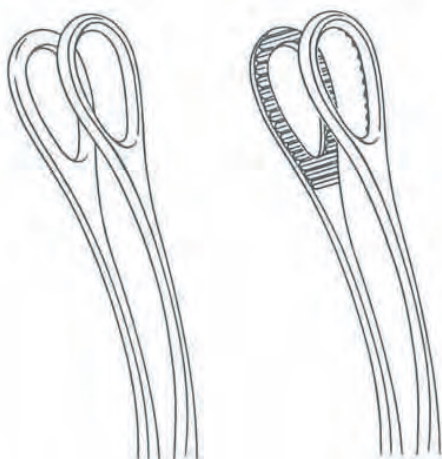

08-192.18=18cm/7" 08-193.18 = 18 cm / 7"
08-192.20=20cm/8" 08-193.20 = 20 cm / 8"
08-192.25=25cm/10" 08-193.25 = 25 cm / 10"



**NADELHALTER
NEEDLE HOLDER**

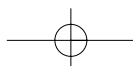
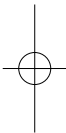
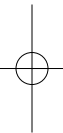
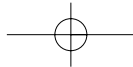

**NADELHALTER
NEEDLE HOLDER**



Derf
05-001.12
120mm / 4¾"



Derf
05-002.12
125mm / 5"



Collier
05-003.12
125mm / 5"

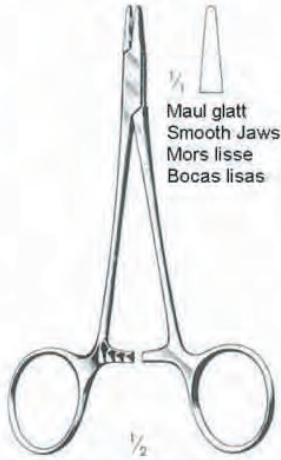

Webster
05-004.13
130mm / 5"

1/4
Maul glatt
Smooth Jaws
Mors lisse
Bocas lisas

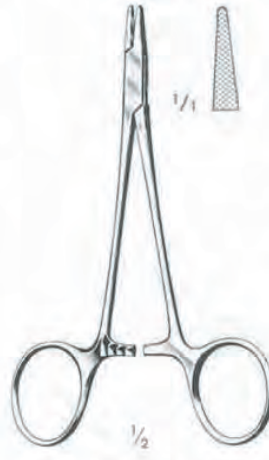

Webster
05-005.13
130mm / 5"

1/4

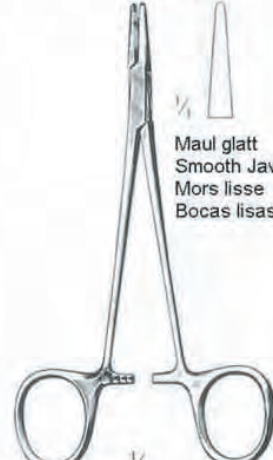

Halsey
05-006.13
130mm / 5"

1/4
Maul glatt
Smooth Jaws
Mors lisse
Bocas lisas



Halsey
05-007.13
130mm / 5"

1/4

NADELHALTER NEEDLE HOLDER

Maul glatt mit Spezialkehle
Smooth Jaws with special groove
Mors lisses avec rainure spéciale
Bocas lisas con acanaladura especial

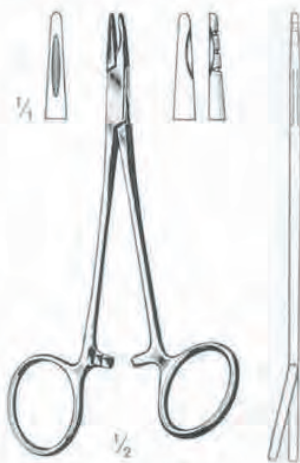

Neivert
05-008.13 130mm / 5"



Hegar-Baumgartner
05-009.14 140mm / 5½"



Blair-Brown
05.010.13 130mm / 5"
05-010.18 180mm / 7"



Senning
05-011.14 145mm / 5¾"
05-011.17 170mm / 6¾"



Crile-Murray
05-012.15 150mm / 6"

**NADELHALTER
NEEDLE HOLDER**



05-013.15
150mm / 6"



05-013.23
230mm / 9"



05-013.18
180mm / 7"



05-013.26
260mm / 10 $\frac{1}{4}$ "



05-013.20
200mm / 8"

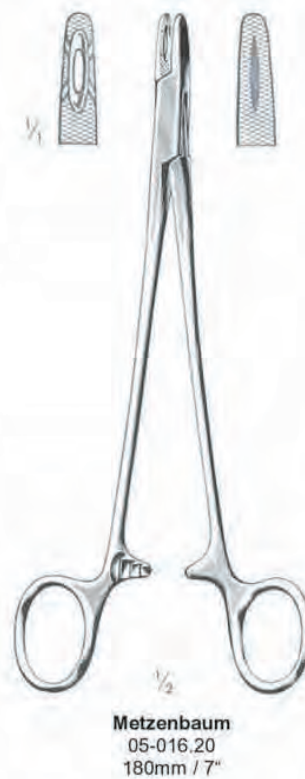

**NADELHALTER
NEEDLE HOLDER**



Sarot



05-017.18
180mm / 7"



05-017.27
270mm / 10½"



Mayo-Hegar



05-018.13
130mm / 5"



05-018.14
140mm / 5½"



05-018.16
160mm / 6¼"



05-018.18
180mm / 7"



05-018.20
200mm / 8"



05-018.24
240mm / 9¼"



05-018.26
260mm / 10¼"



05-018.30
300mm / 12"

**NADELHALTER
NEEDLE HOLDER**

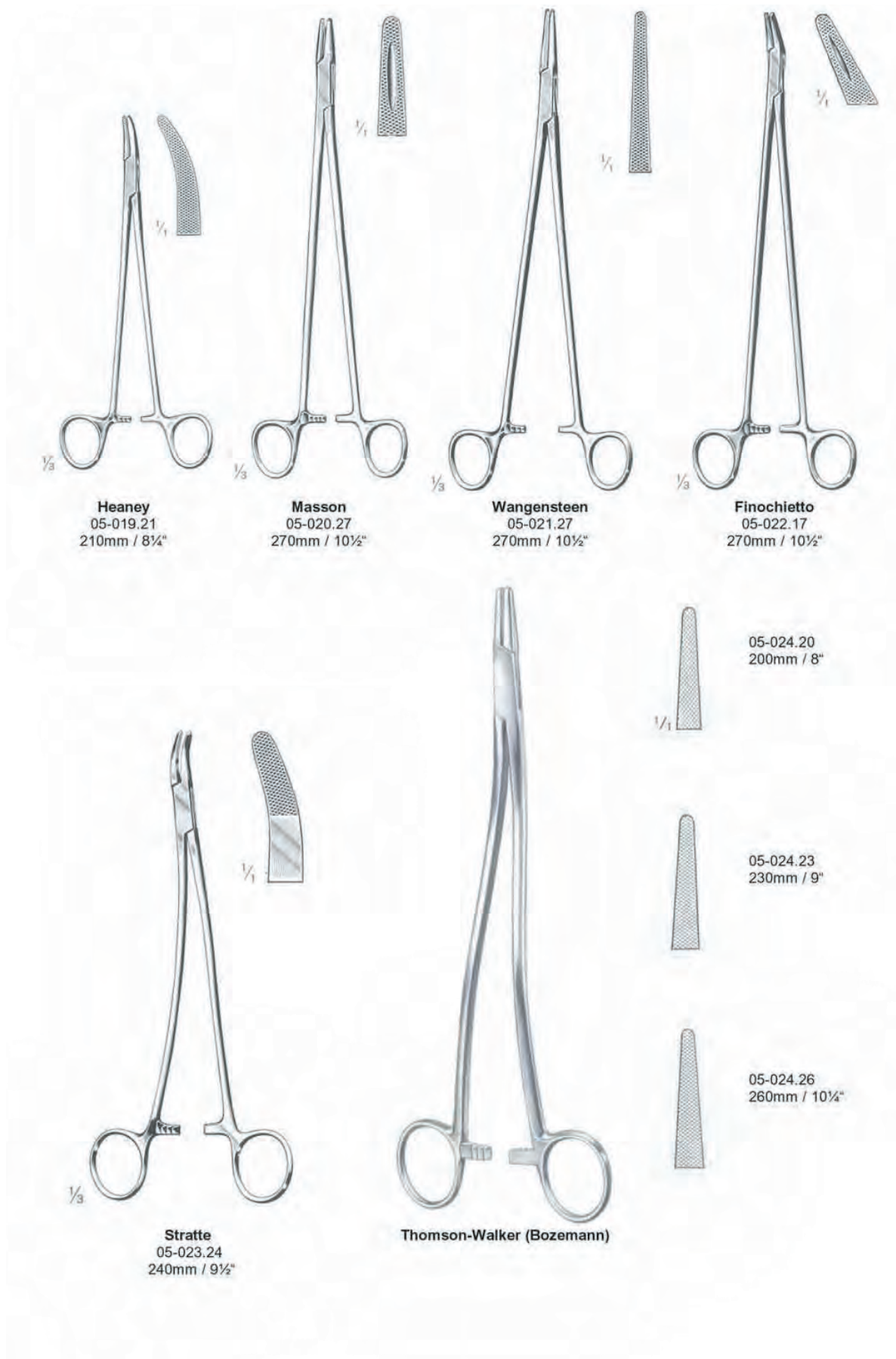

**NADELHALTER
NEEDLE HOLDER**

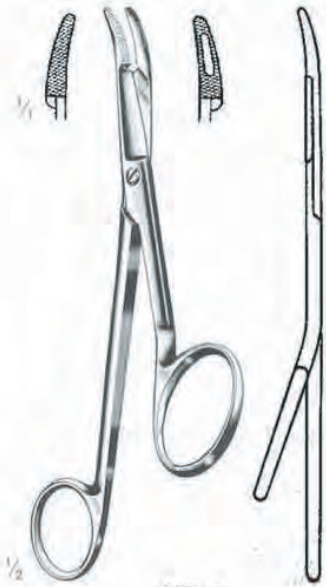

Gillies
05-025.16
160mm / 6 1/4"



Olsen-Hegar-Mini
05-026.12
125mm / 5"



Olsen-Hegar



05-026.14
140mm / 5 1/2"



05-026.17
170mm / 6 3/4"



05-026.19
190mm / 7 1/2"

**NADELHALTER
NEEDLE HOLDER**



Langenbeck Mod. Wien



Mathieu-Kocher
schlank
fine
délicat
delicado

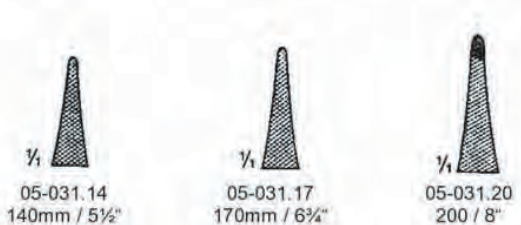

**NADELHALTER
NEEDLE HOLDER**

$\frac{1}{16}$
05-028.14
140mm / 5½"

$\frac{1}{16}$
05-028.17
170mm / 6¾"

$\frac{1}{16}$
05-028.20
200mm / 8"

$\frac{1}{16}$
05-029.14
140mm / 5½"

$\frac{1}{16}$
05-029.17
170mm / 6¾"

$\frac{1}{16}$
05-029.20
200mm / 8"



Mathieu

$\frac{1}{16}$
05-030.01
170mm / 6¾"

$\frac{1}{16}$
05-030.02
200mm / 8"

$\frac{1}{16}$
05-030.03
170mm / 6¾"

$\frac{1}{16}$
05-030.04
200mm / 8"



Mathieu

**NADELHALTER
NEEDLE HOLDER**

**Nadelhalter mit Hartmetalleinsätzen
Needle Holders with Tungsten Carbide Inserts**

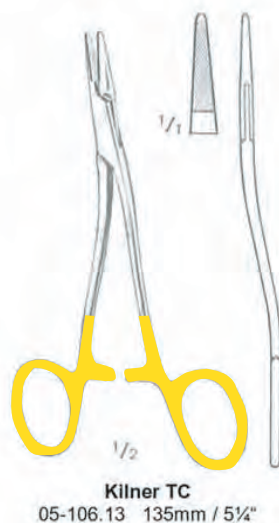
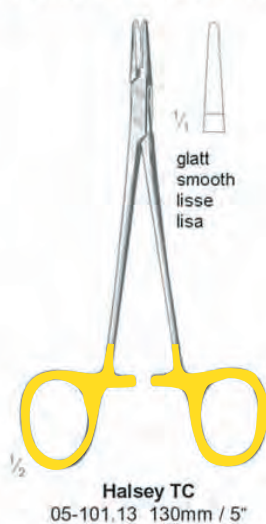
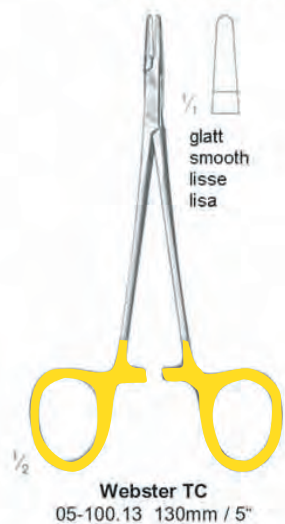

**NADELHALTER
NEEDLE HOLDER**

**Nadelhalter mit Hartmetalleinsätzen
Needle Holders with Tungsten Carbide Inserts**



Senning TC
05-107.15 150mm / 6"
05-107.17 170mm / 6½"



Crile-Wood TC

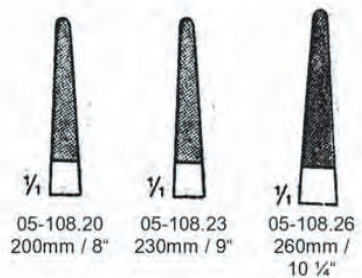
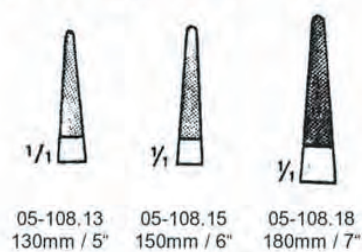

DeBakey TC

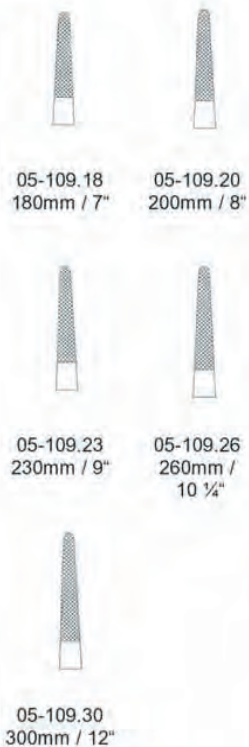

Mikro-Vascular TC

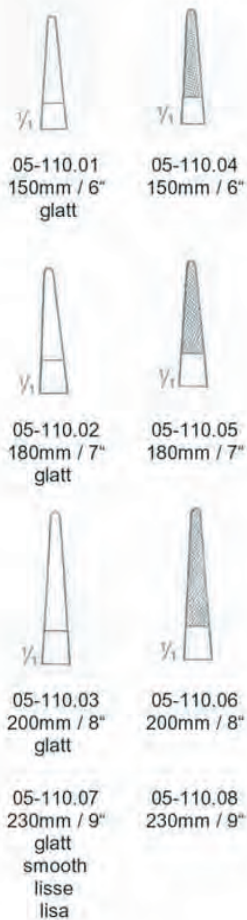

**NADELHALTER
NEEDLE HOLDER**

**Nadelhalter mit Hartmetalleinsätzen
Needle Holders with Tungsten Carbide Inserts**

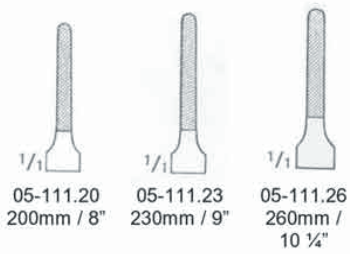
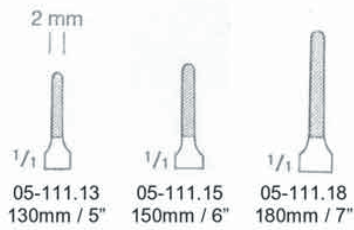

Ryder/French Eye TC 2mm

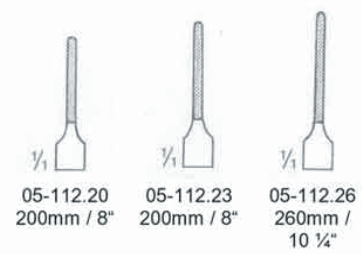
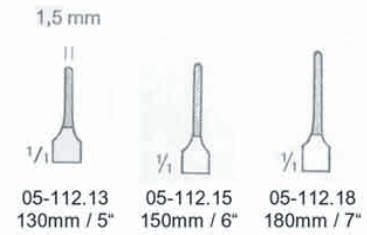

Hufnagel-Ryder TC 1,5mm

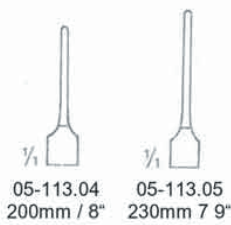
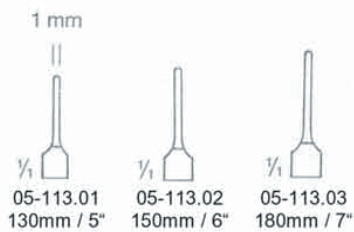
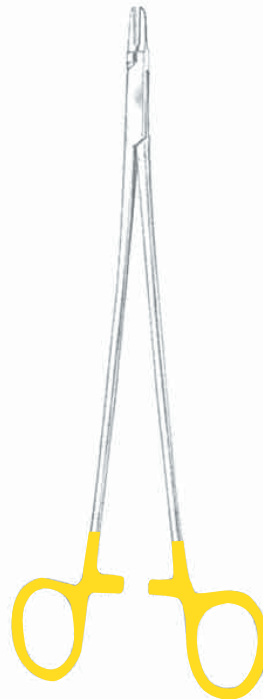

glatt
smooth
lisse
lisa



Mikro-Ryder TC 1mm

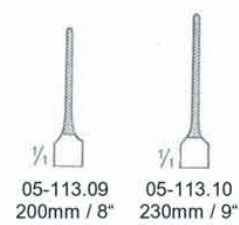
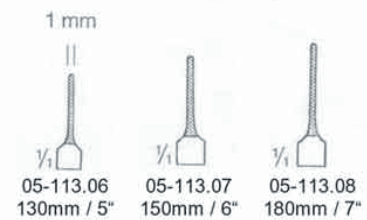

**NADELHALTER
NEEDLE HOLDER**

**Nadelhalter mit Hartmetalleinsätzen
Needle Holders with Tungsten Carbide Inserts**



New Orleans TC
05-114.18
180mm / 7"



Sarot TC

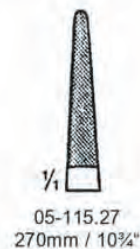
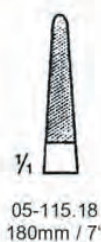

05-115.20
200mm / 8"

Besonders feines Modell für
Gefäßnaht und Herzgefäßchirurgie
Especially fine pattern
for vascular and cardiovascular suture



05-116.01
140mm / 5 1/2"



05-116.02
200mm / 8"

glatt
smooth
lisse
lisa



Intracardiac TC



05-116.03
140mm / 5 1/2"



05-116.04
200mm / 8"

**NADELHALTER
NEEDLE HOLDER**

**Nadelhalter mit Hartmetalleinsätzen
Needle Holders with Tungsten Carbide Inserts**

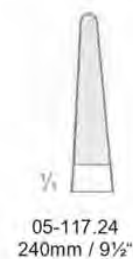

Mayo-Hegar TC



Heaney TC
05-118.21 210mm / 8¼"
05-118.26 260mm / 10¼"



Masson TC
05-119.27
270mm / 10¾"



Wangenstein TC
05-120.27
270mm / 10¾"

**NADELHALTER
NEEDLE HOLDER**

**Nadelhalter mit Hartmetalleinsätzen
Needle Holders with Tungsten Carbide Inserts**

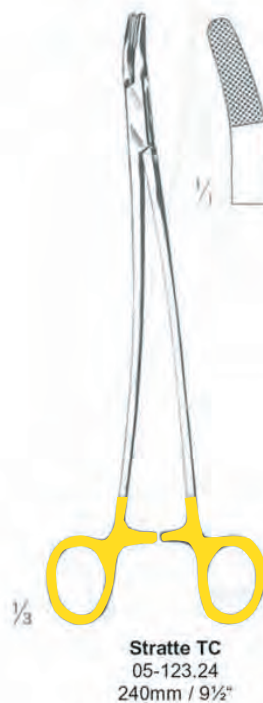

**NADELHALTER
NEEDLE HOLDER**

**Nadelhalter mit Hartmetalleinsätzen
Needle Holders with Tungsten Carbide Inserts**

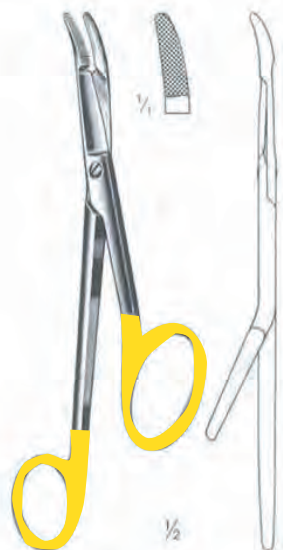

Gillies TC
05-124.16
160mm / 6 1/2"



Olsen-Hegar-Mini TC



05-125.01
125mm / 5"

glatt
smooth
lisse
lisa



05-125.02
125mm / 5"



Olsen-Hegar



05-125.03
140mm / 5 1/2"



05-125.04
170mm / 6 3/4"



05-125.05
190mm / 7 1/2"

**NADELHALTER
NEEDLE HOLDER**

**Nadelhalter mit Hartmetalleinsätzen
Needle Holders with Tungsten Carbide Inserts**



Toennis TC
05-126.18
180mm / 7"



Langenbeck-Ryder TC
05-127.20
200mm / 8"



Langenbeck TC Wiener Modell



05-128.16
160mm / 6 1/4"



05-128.18
180mm / 7"



05-128.20
200mm / 8"



05-128.23
230mm / 9"

**NADELHALTER
NEEDLE HOLDER**

**Nadelhalter mit Hartmetalleinsätzen
Needle Holders with Tungsten Carbide Inserts**



Mathieu TC



05-129.14
140mm / 5½"



05-129.17
170mm / 6¾"



05-129.20
200mm / 8"



Mathieu TC



05-130.14
140mm / 5½"



05-130.17
170mm / 6¾"



05-130.20
200mm / 8"

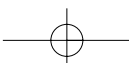
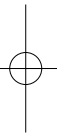
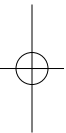
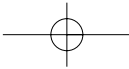



WUNDHAKEN RETRACTORS

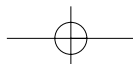
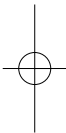
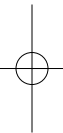
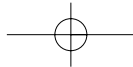

**WUNDHAKEN
RETRACTORS**

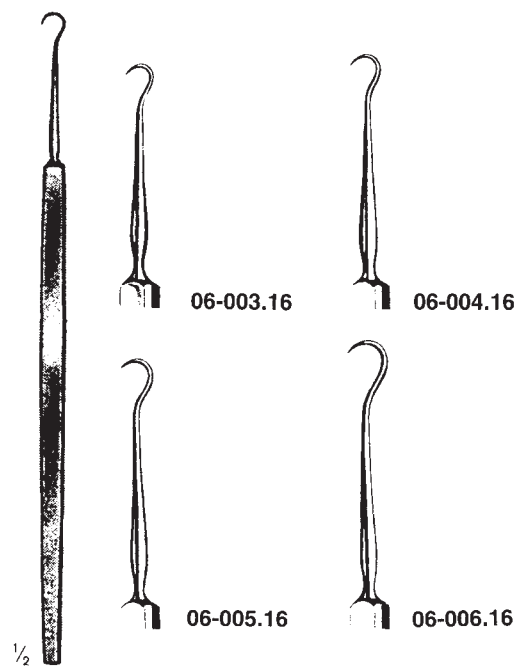
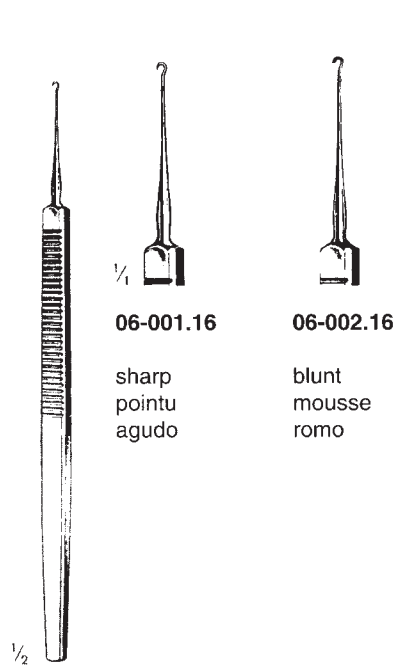

Graefe

16 cm / 6 1/4"

16 cm / 6 1/4"

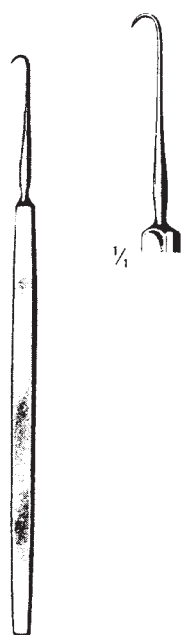

O'Connor
06-007.16
16 cm / 6 1/4"

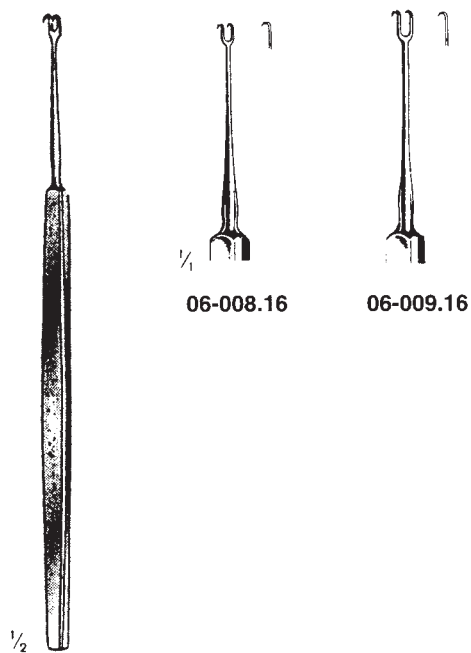

Guthrie
16 cm / 6 1/4"

**WUNDHAKEN
RETRACTORS**

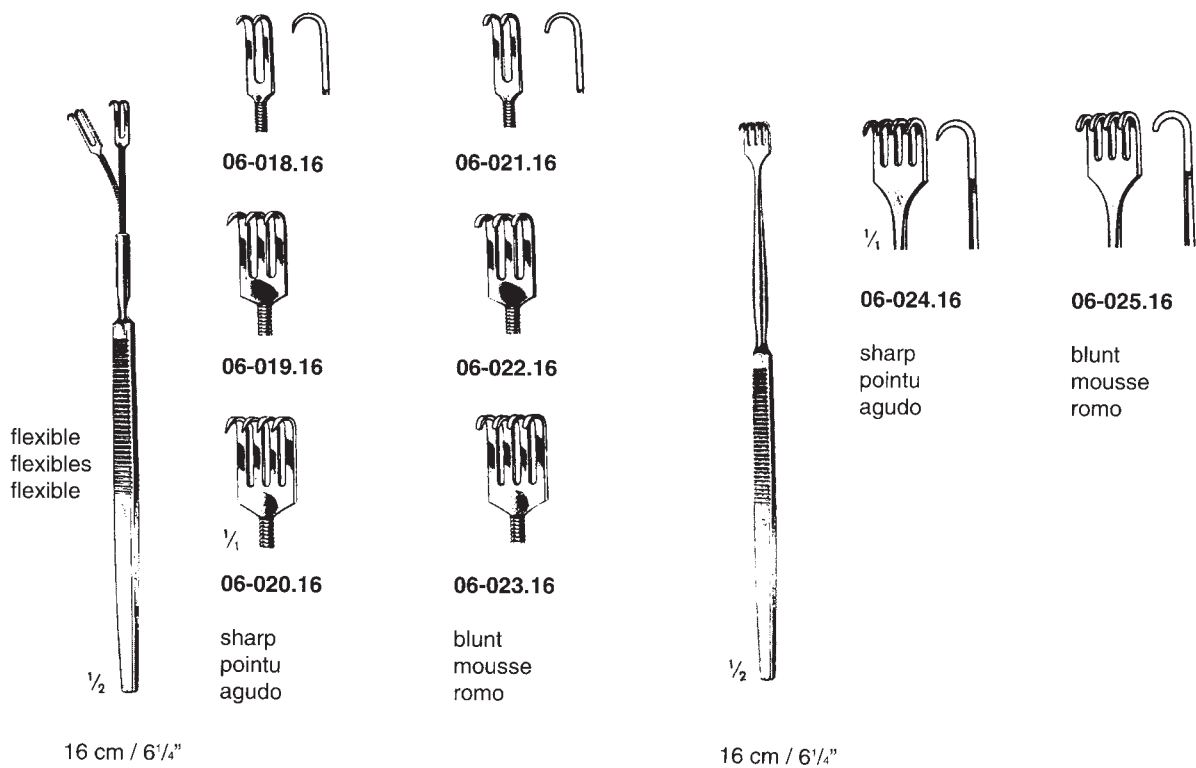
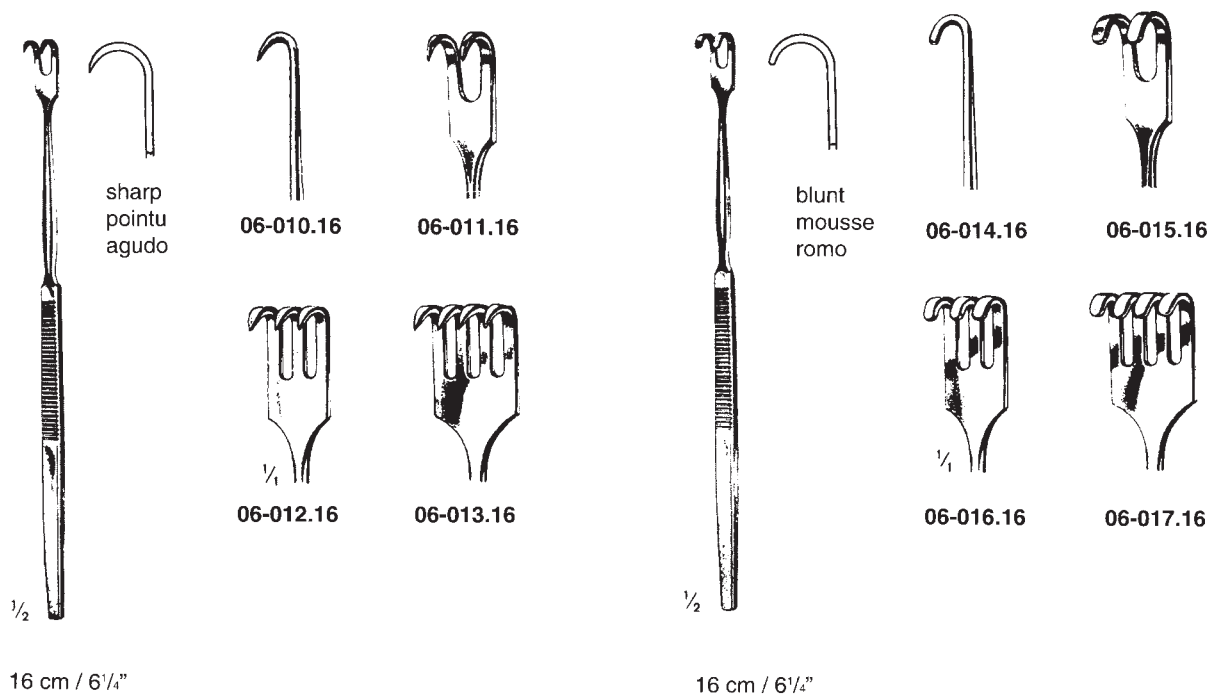

**WUNDHAKEN
RETRACTORS**

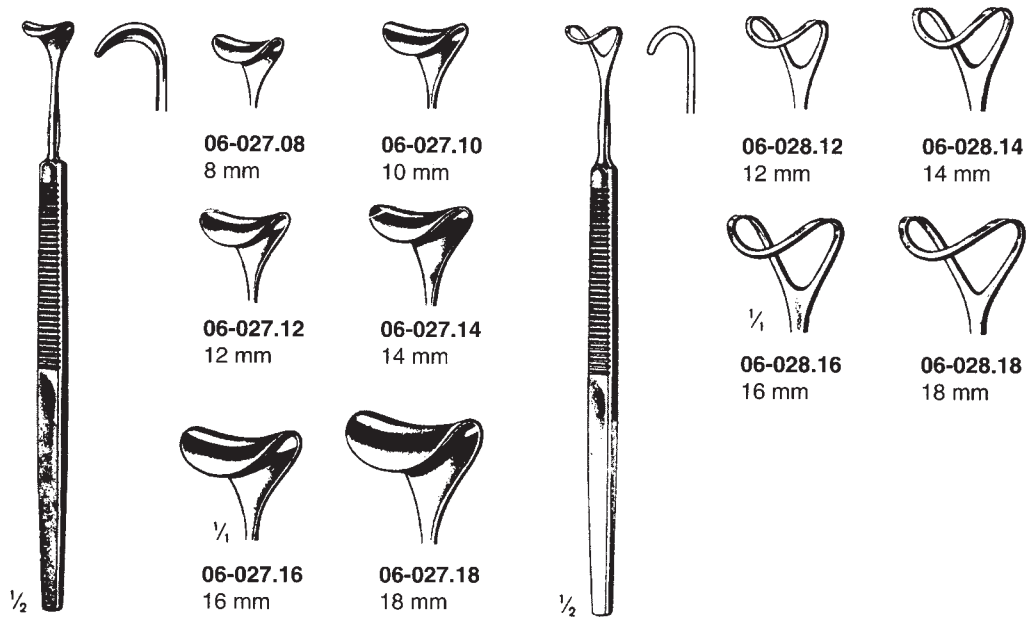

Desmarres

16 cm / 6 1/4"

16 cm / 6 1/4"

**WUNDHAKEN
RETRACTORS**

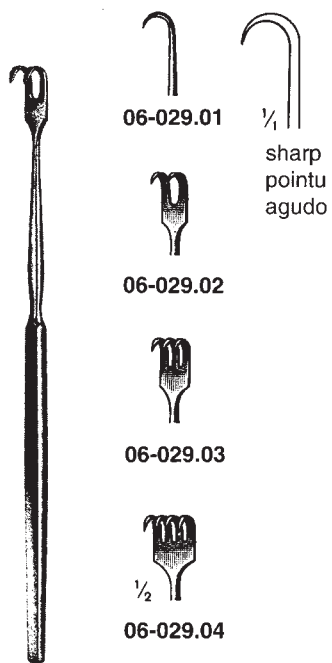

16 cm / 6 1/4"

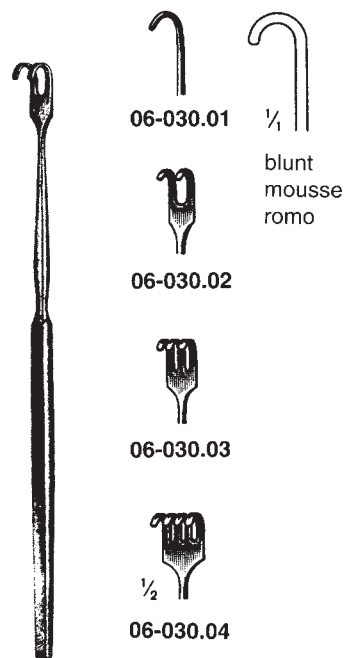

16 cm / 6 1/4"

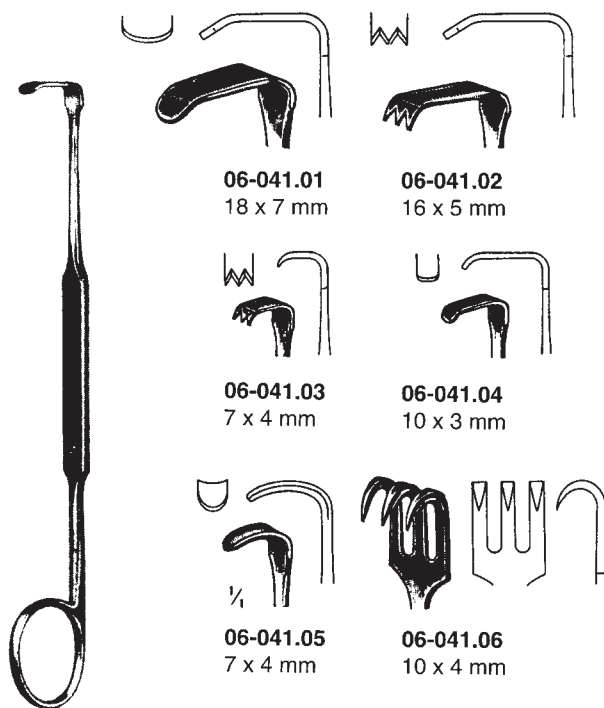
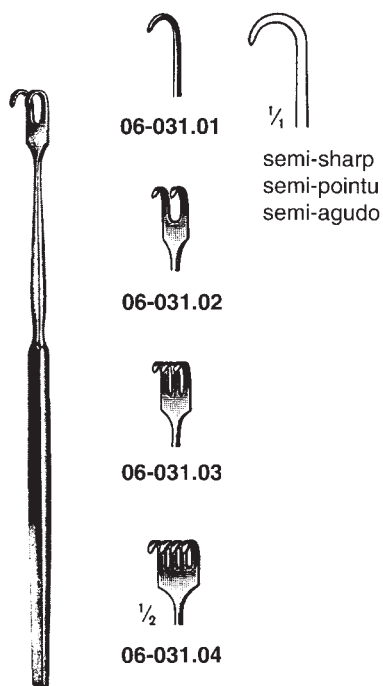

Meyerding

18 cm / 7"

**WUNDHAKEN
RETRACTORS**

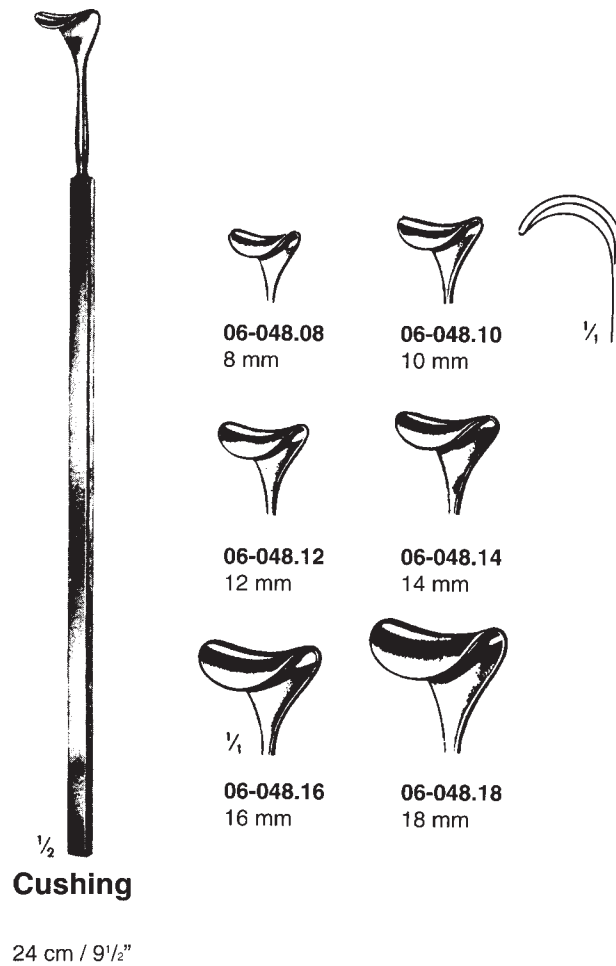
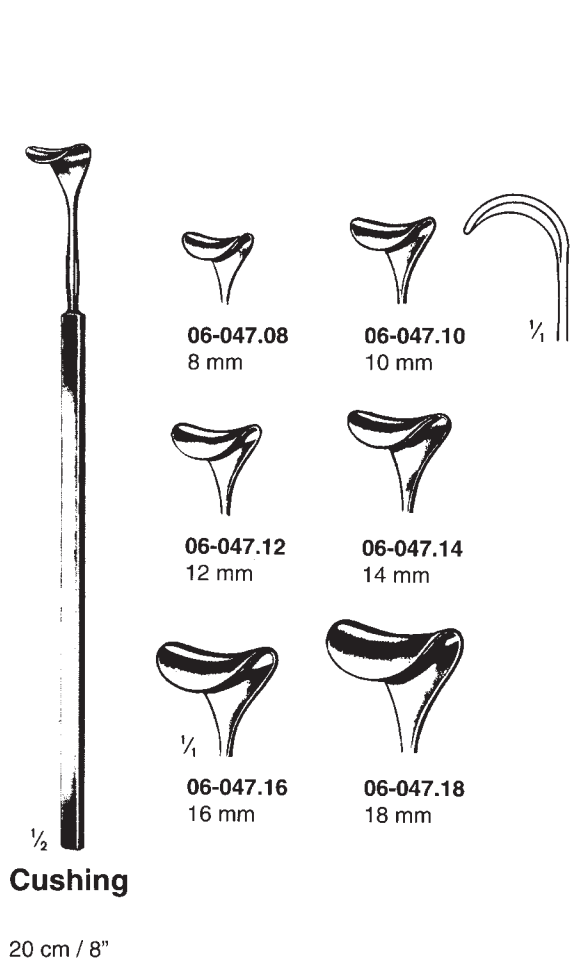

**WUNDHAKEN
RETRACTORS**

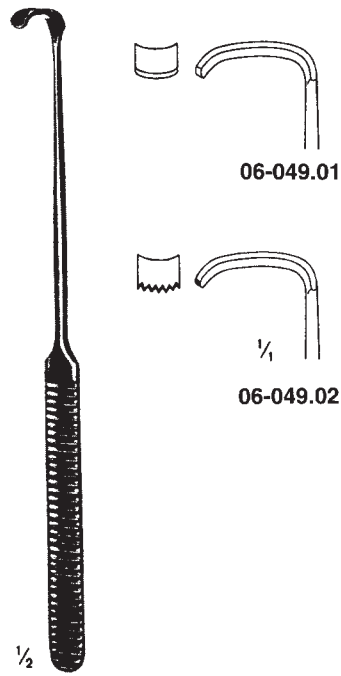

Strandell-Style

19 cm / 7 1/2"



1/2

Volkman
23 cm / 9"

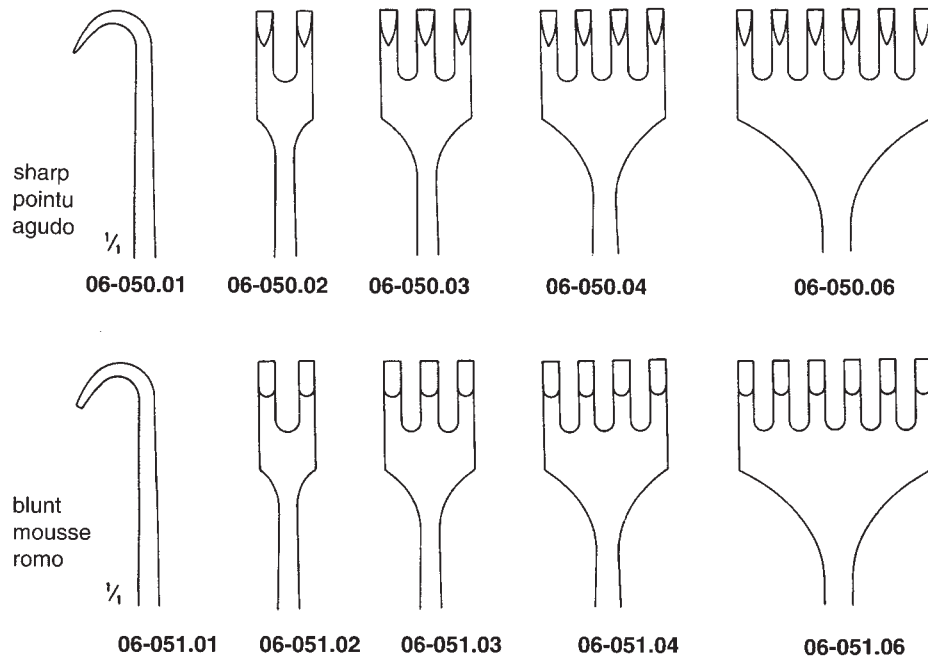

**WUNDHAKEN
RETRACTORS**

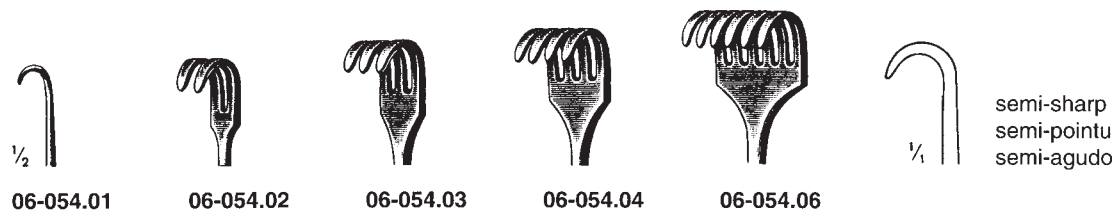
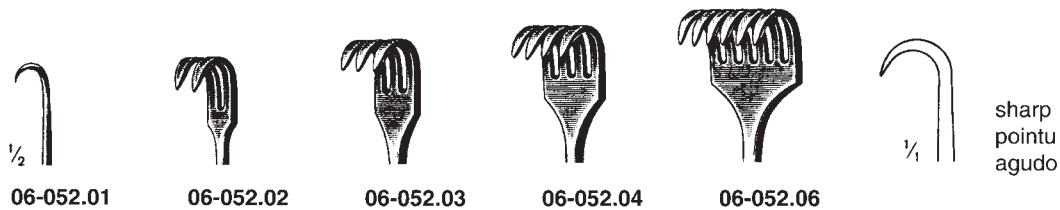

Volkman
21,5 cm / 8 1/2"

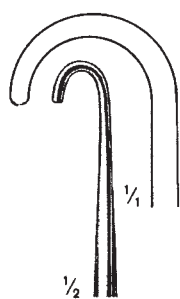

Volkman
06-055.01
21,5 cm / 8 1/2"

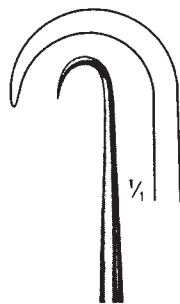

Volkman
06-056.01
21,5 cm / 8 1/2"

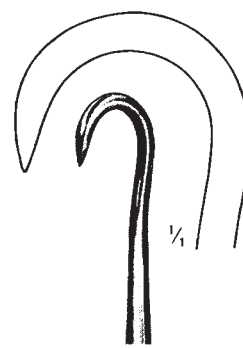

06-057-01
20 cm / 8"
sharp pointu agudo

06-058.01
20 cm / 8"
blunt mousse romo

**WUNDHAKEN
RETRACTORS**

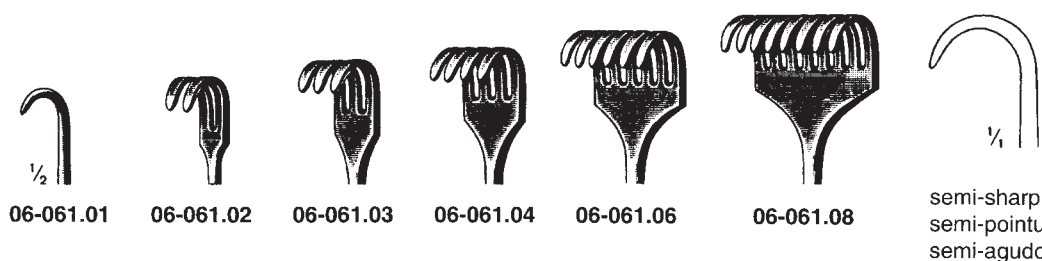
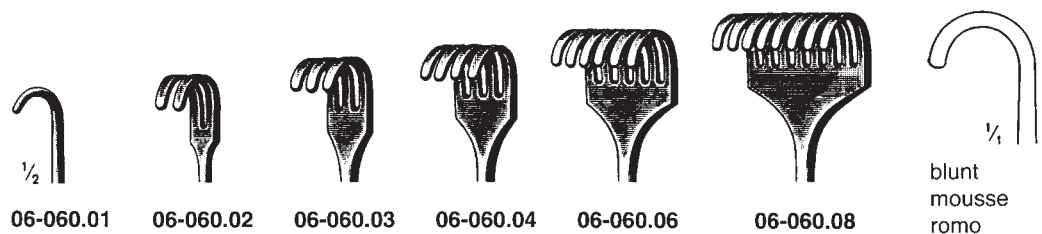
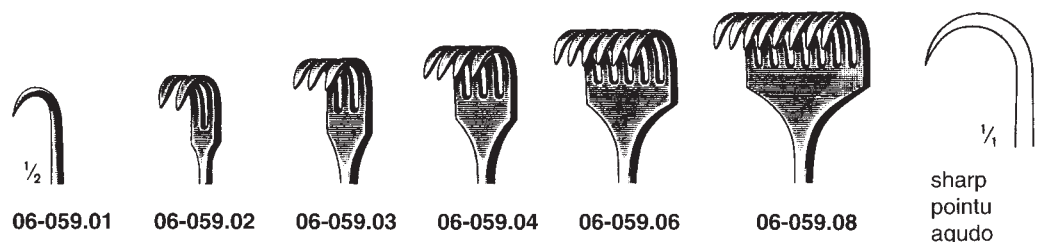

$\frac{1}{2}$
Kocher

22 cm / 8 $\frac{3}{4}$ "

**WUNDHAKEN
RETRACTORS**

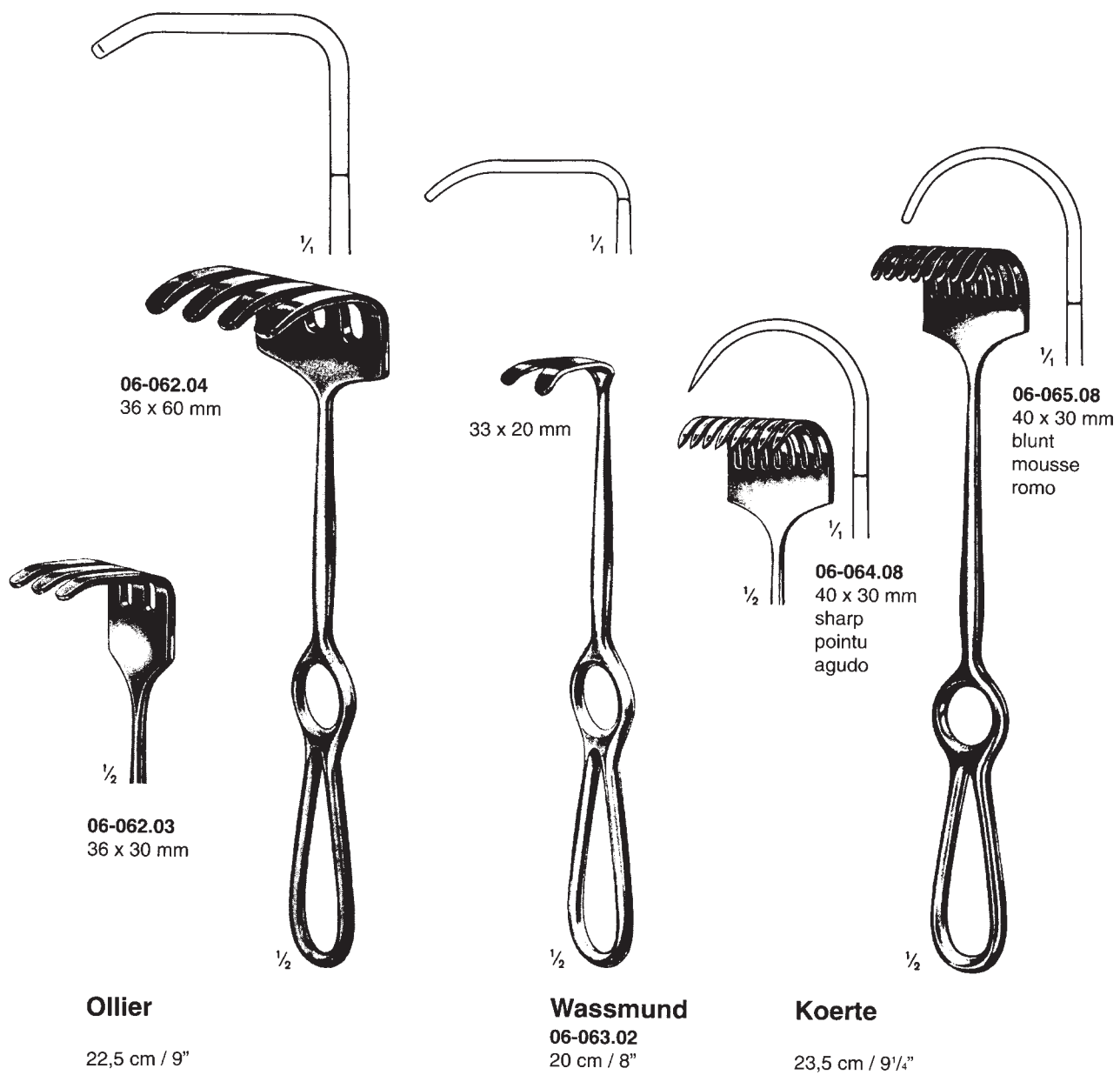

**WUNDHAKEN
RETRACTORS**



Israel

25 cm / 10"

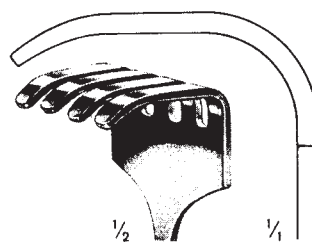

06-066.04
40 x 40 mm

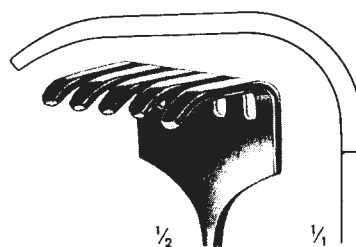

06-066.05
45 x 50 mm

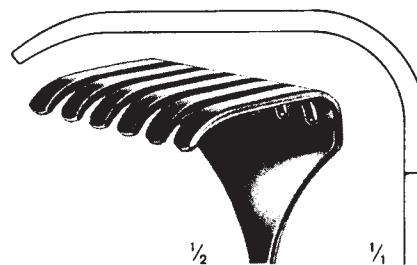

06-066.06
50 x 60 mm

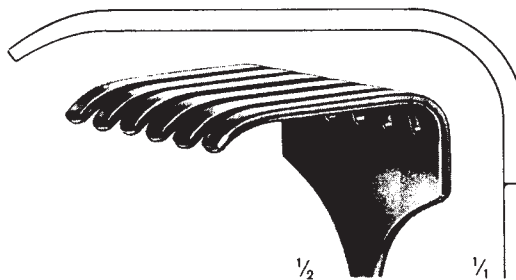

06-066.07
70 x 70 mm

**WUNDHAKEN
RETRACTORS**



1/2

Langenbeck

22 cm / 8 1/2"



1/2

Langenbeck

21 cm / 8 1/4"

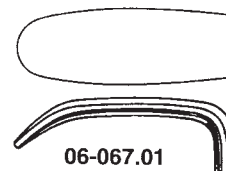

**06-067.01
06-068.01**
30 x 11 mm

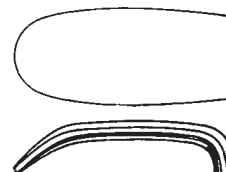

**06-067.02
06-068.02**
30 x 14 mm



**06-067.03
06-068.03**
30 x 16 mm

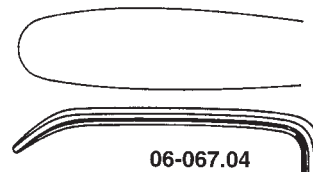

**06-067.04
06-068.04**
40 x 11 mm

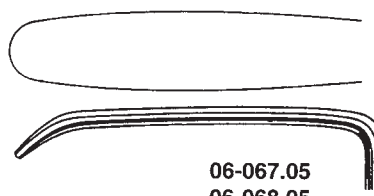

**06-067.05
06-068.05**
50 x 11 mm

1/4

**WUNDHAKEN
RETRACTORS**

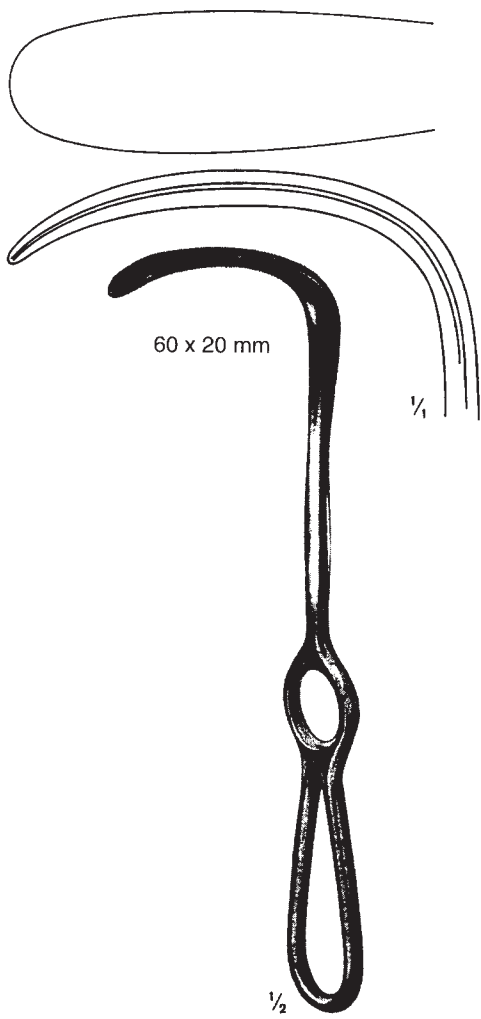

Langenbeck
06-069.21
21 cm / 8 1/4"

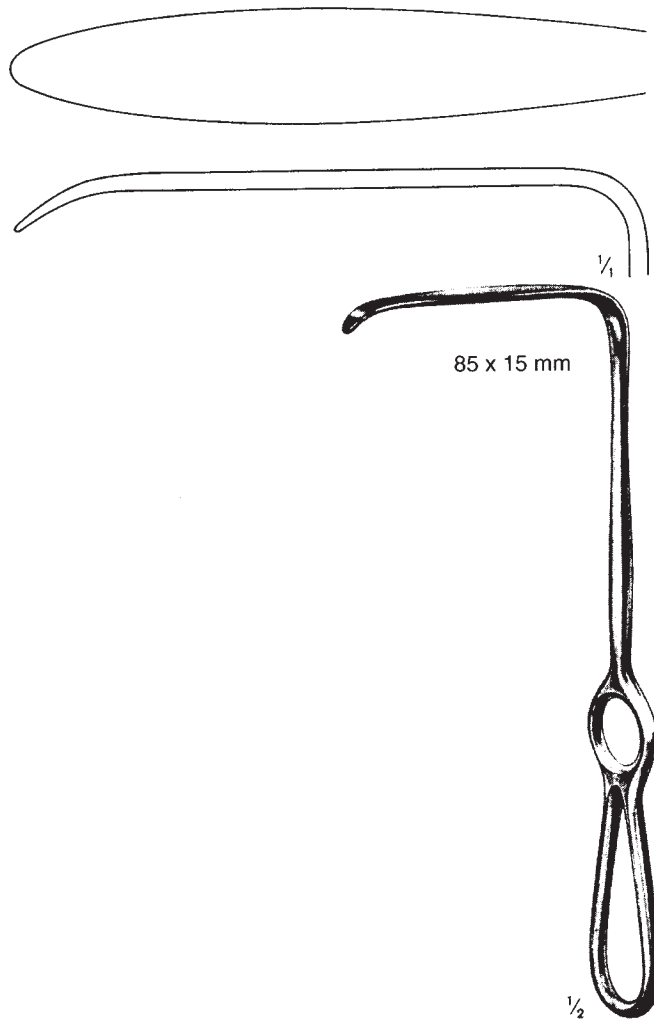

Langenbeck
06-070.21
21 cm / 8 1/4"

**WUNDHAKEN
RETRACTORS**



1/2

Kocher

23 cm / 9"

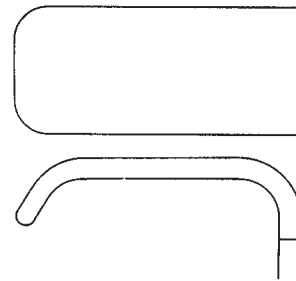

06-071.18
40 x 18 mm

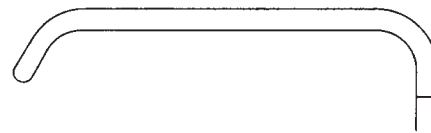

06-071.20
60 x 20 mm



06-071.25
60 x 25 mm

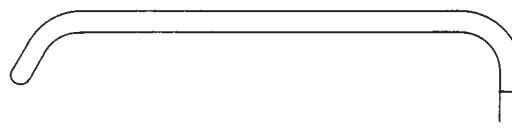

06-071.30
75 x 30 mm



1/4

06-071.40
75 x 40 mm

**WUNDHAKEN
RETRACTORS**



1/2

Kocher-Langenbeck

21,5 cm / 8 1/2"

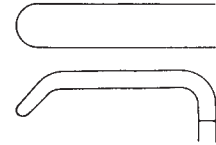

06-072.01
25 x 6 mm



06-072.02
35 x 8 mm



06-072.03
35 x 11 mm



06-072.04
35 x 15 mm



06-072.05
40 x 11 mm



06-072.06
55 x 11 mm



06-072.07
70 x 14 mm



06-072.08
80 x 12 mm



1/1

06-072.09
80 x 16 mm

**WUNDHAKEN
RETRACTORS**

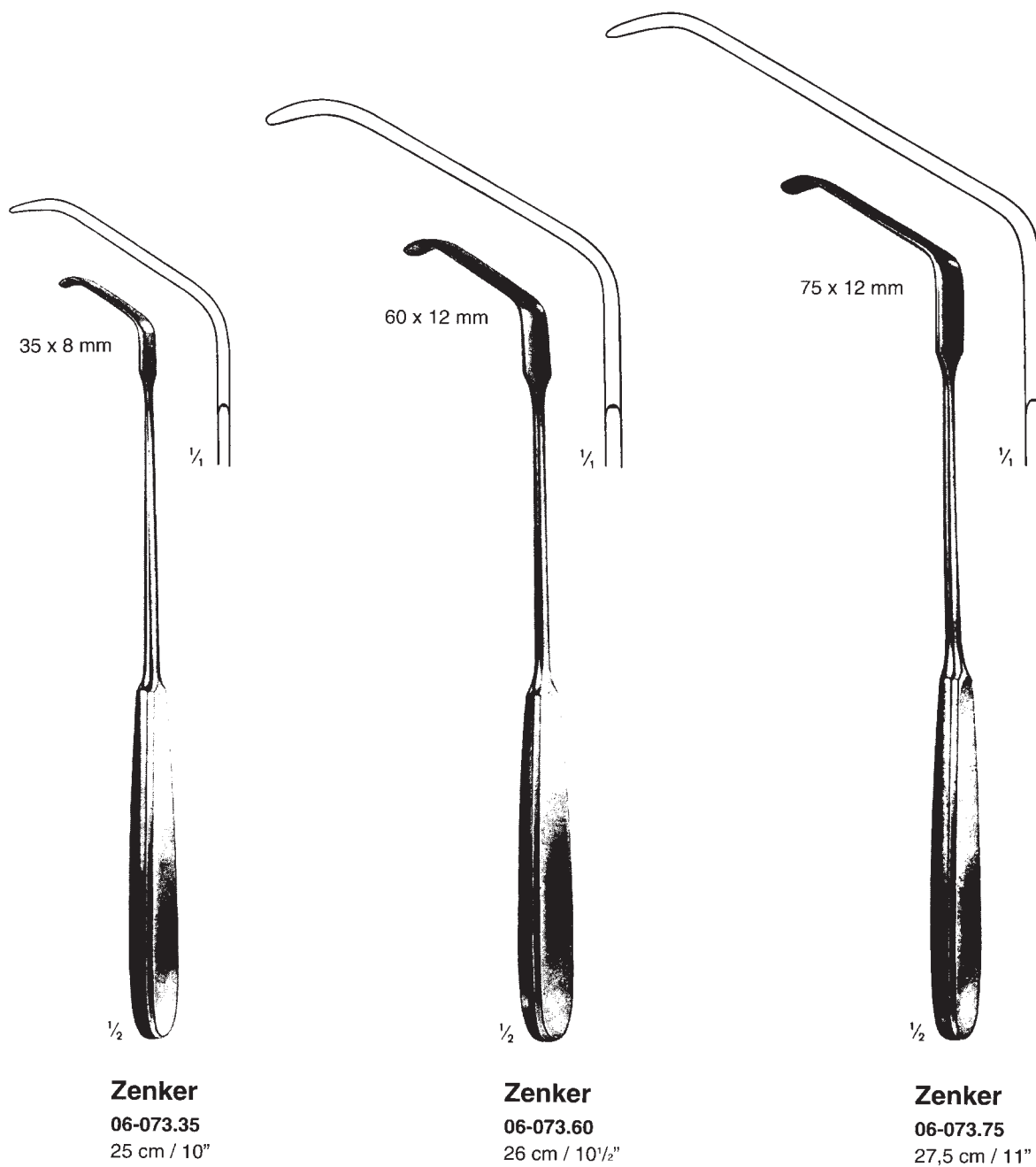

**WUNDHAKEN
RETRACTORS**

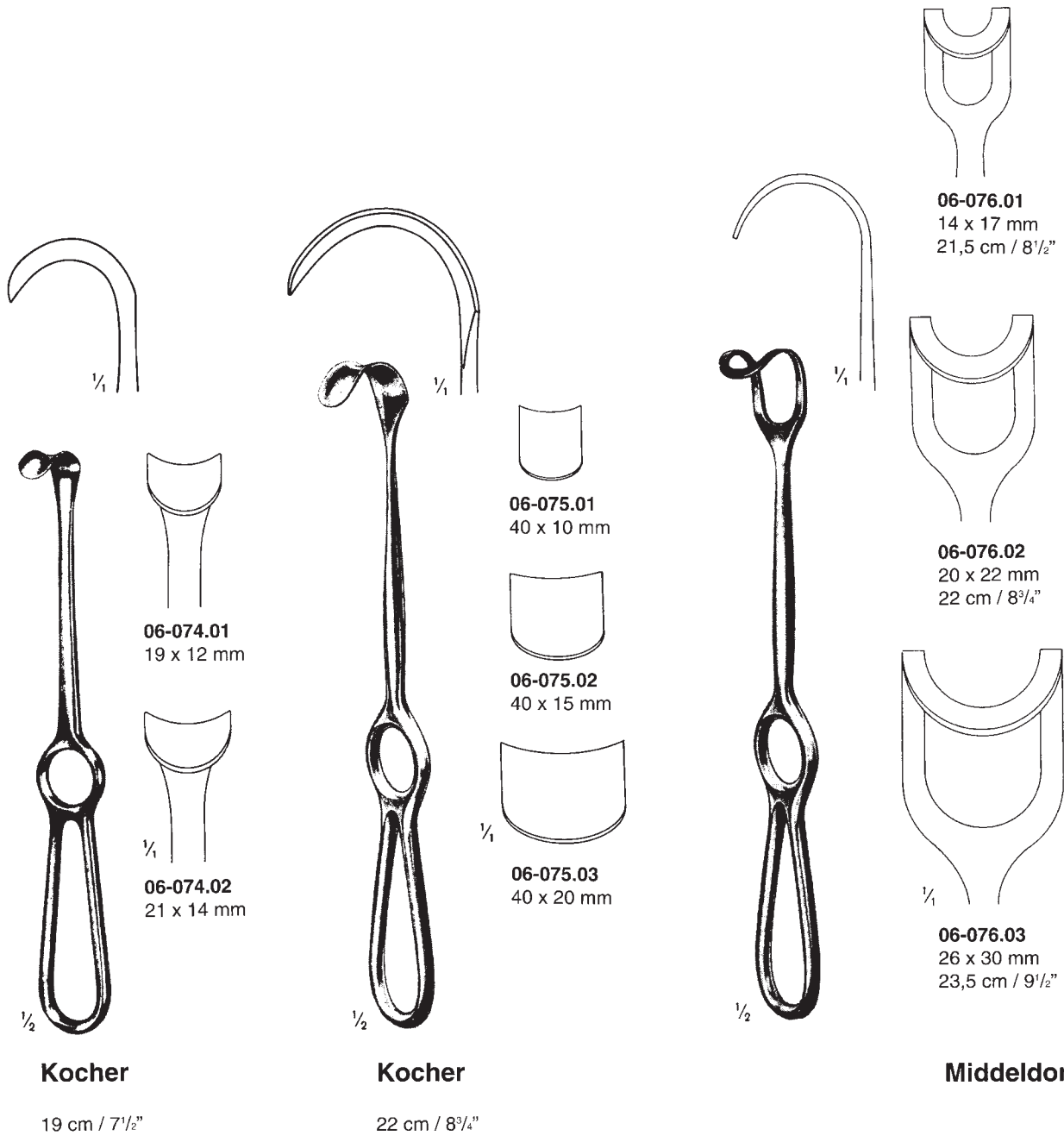

**WUNDHAKEN
RETRACTORS**

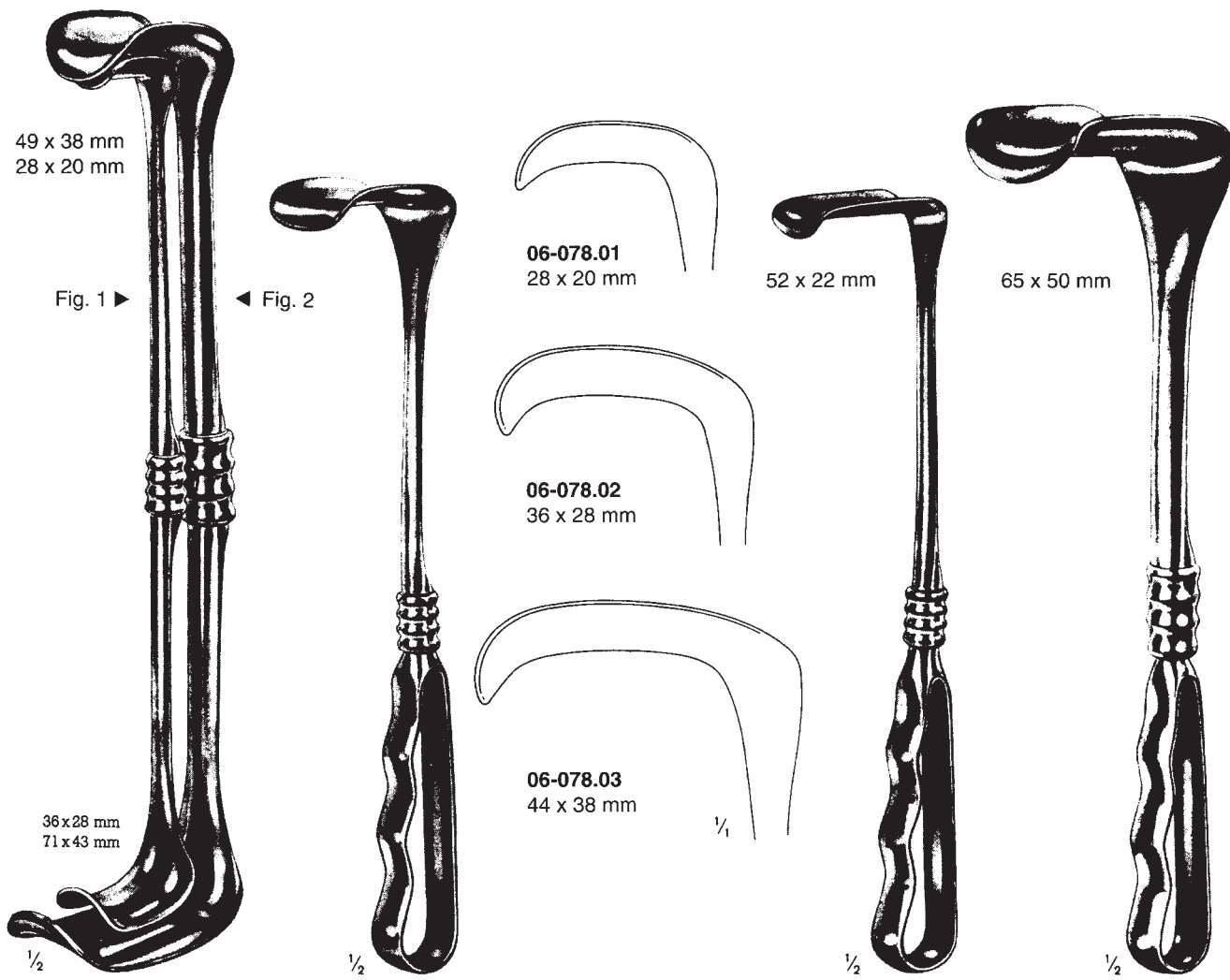

Richardson-Eastmann **Richardson**
 06-077.00 = Set, jeu, juego
 06-077.01 = Fig. 1 = 26 cm / 10 1/4" 24 cm / 9 1/2"
 06-077.02 = Fig. 2 = 28 cm / 11"

Richardson
 06-079.24
 24 cm / 9 1/2"

Kelly
 06-080.26
 26 cm / 10 1/4"

**WUNDHAKEN
RETRACTORS**

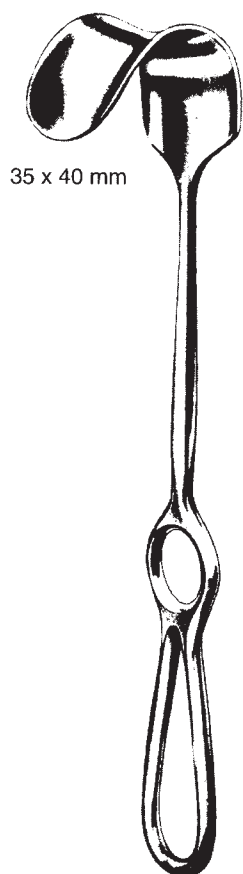
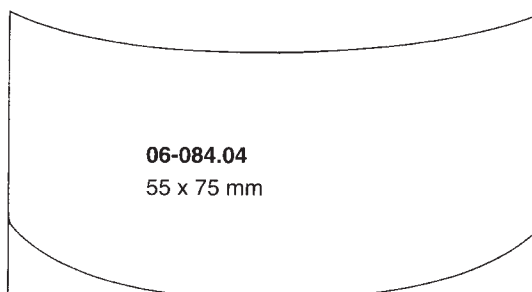
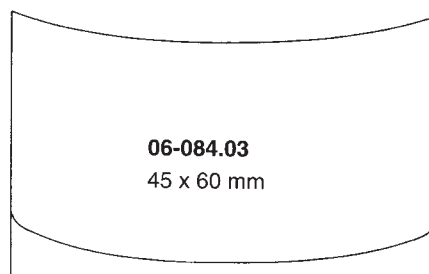
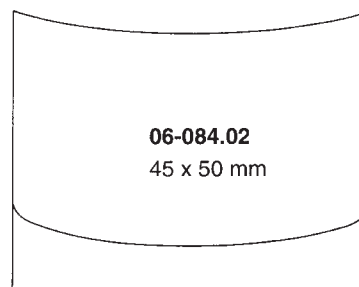
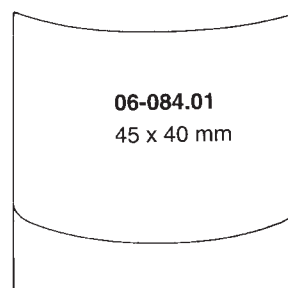
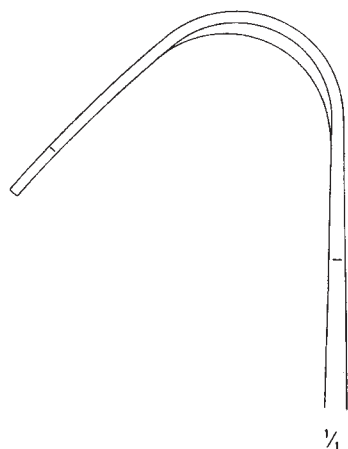
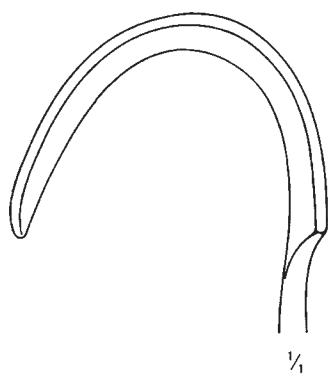

Fritsch
06-083.24
24 cm / 9 1/2"

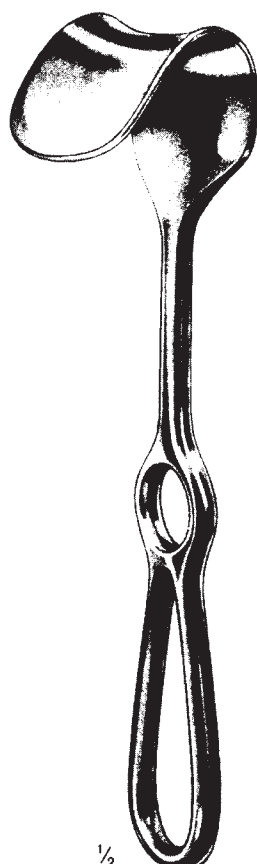

Fritsch
24 cm / 9 1/2"

**WUNDHAKEN
RETRACTORS**

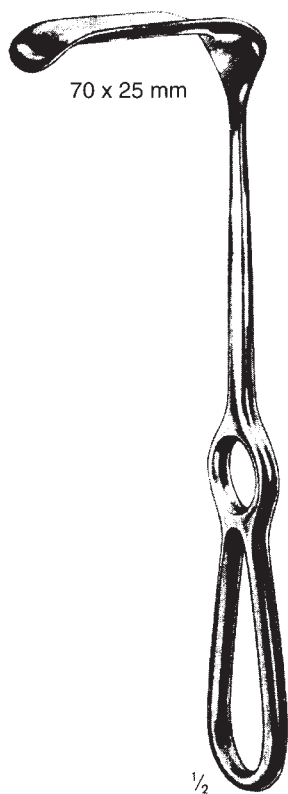

$\frac{1}{2}$
Kocher
06-085.22
22,5 cm / 9"

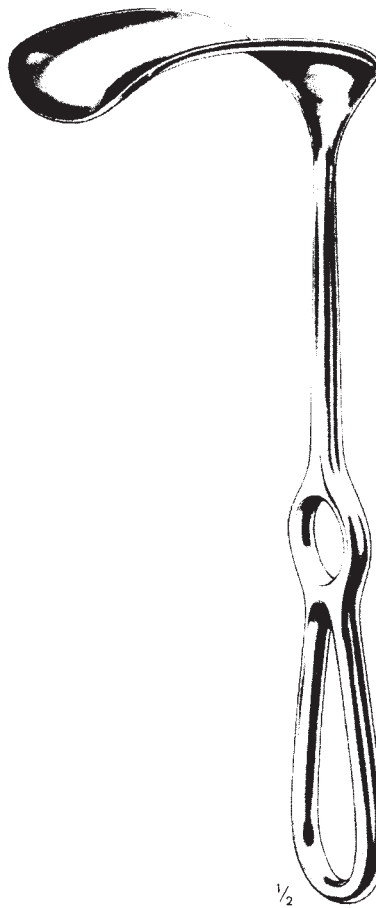

$\frac{1}{2}$
Kocher
25 cm / 10"
06-086.01 = 80 x 45 mm
06-086.02 = 80 x 55 mm
06-086.03 = 80 x 65 mm

**WUNDHAKEN
RETRACTORS**

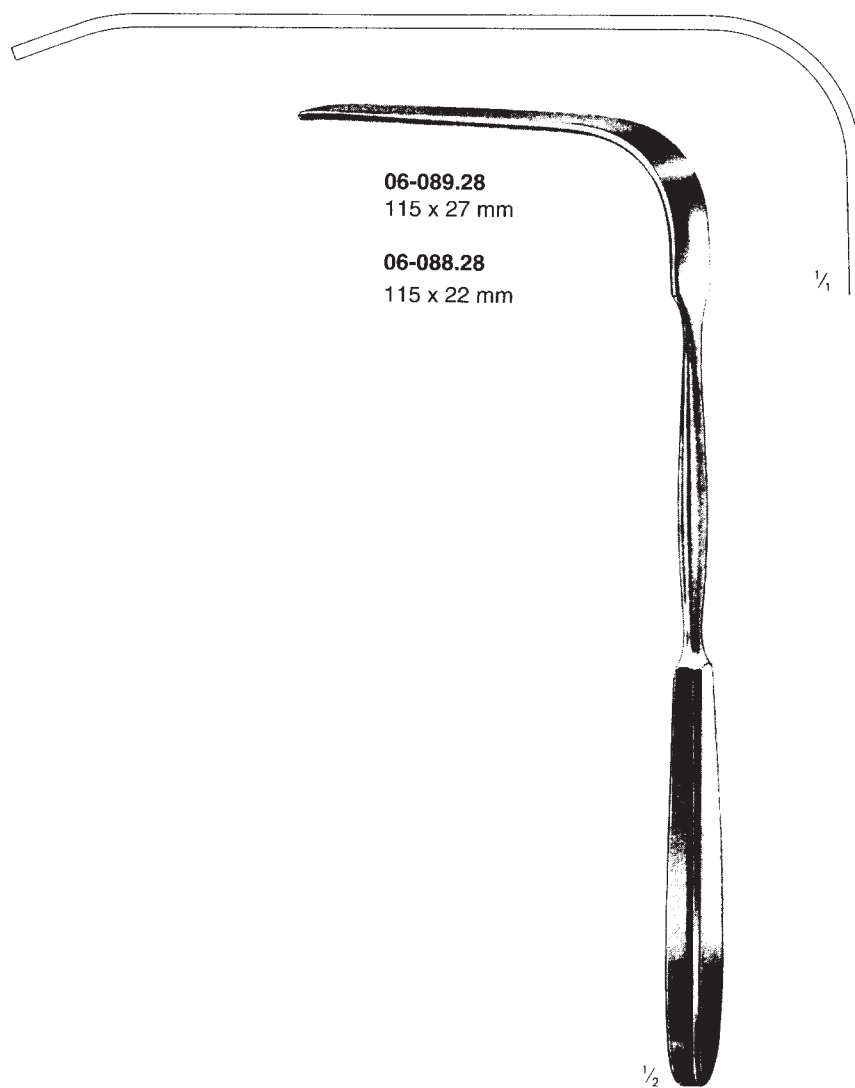

Simon

28 cm / 11"

**WUNDHAKEN
RETRACTORS**

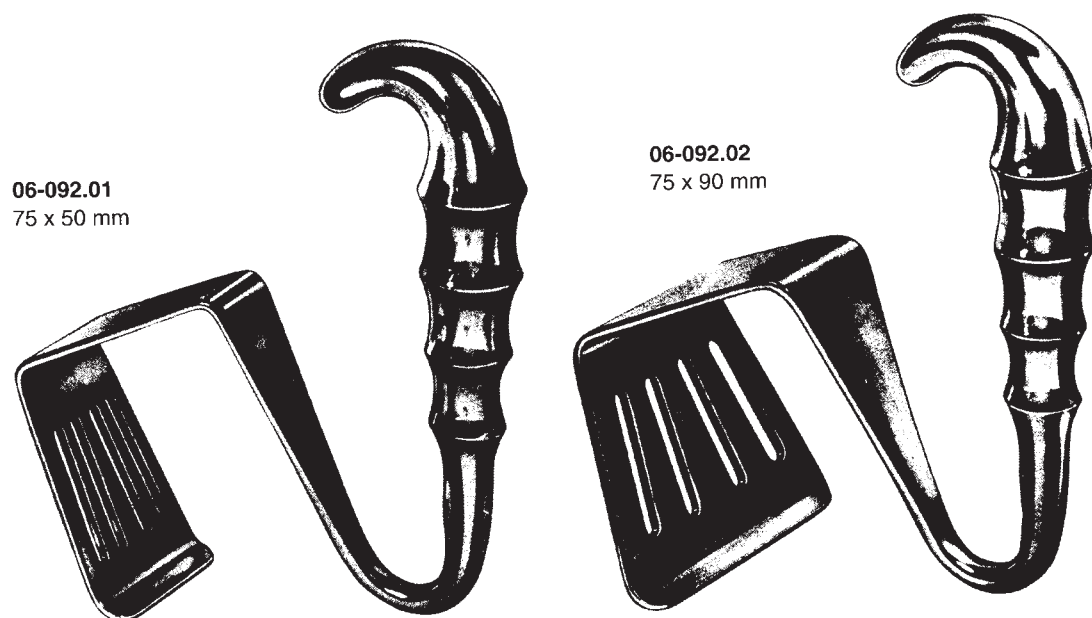

06-092.01
75 x 50 mm

06-092.02
75 x 90 mm

Davidson

16 cm / 6 1/4"
(Scapula)

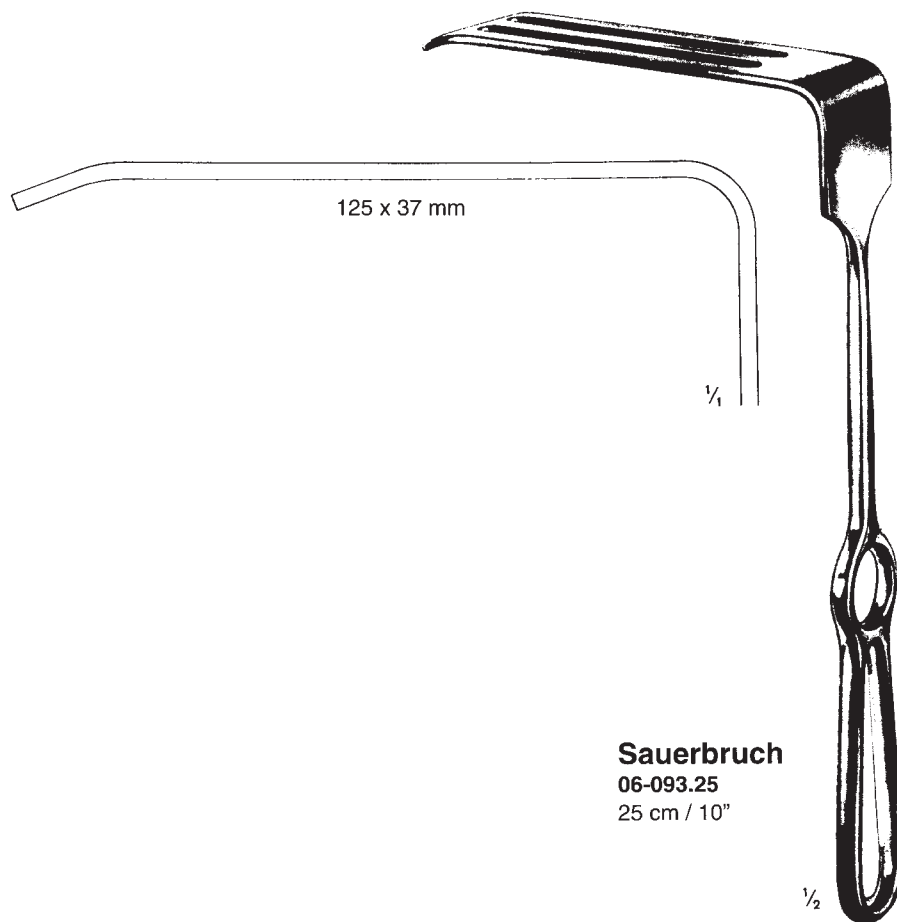

125 x 37 mm

Sauerbruch
06-093.25
25 cm / 10"

1/2

**WUNDHAKEN
RETRACTORS**

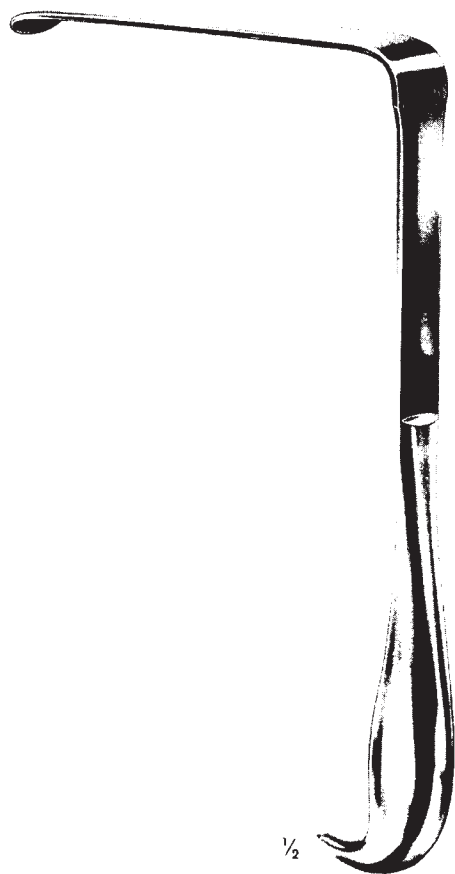
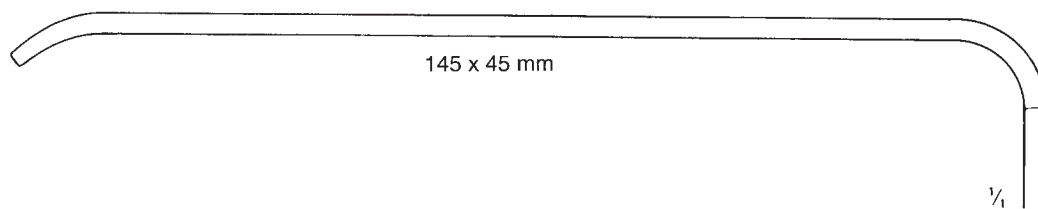

Brunner
06-094.24
24 cm / 9 $\frac{1}{2}$ "

**WUNDHAKEN
RETRACTORS**

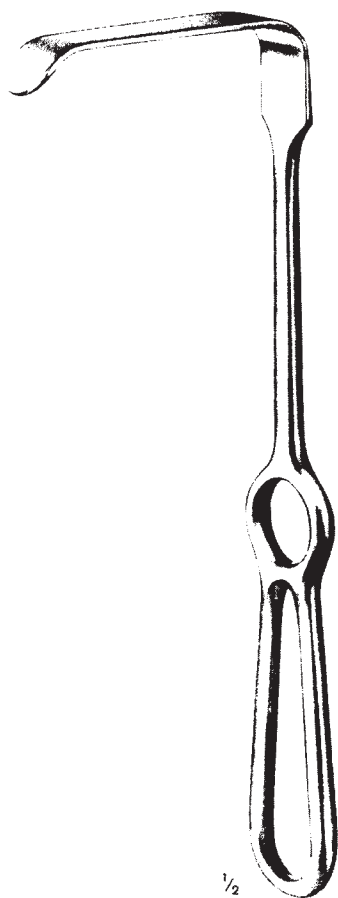
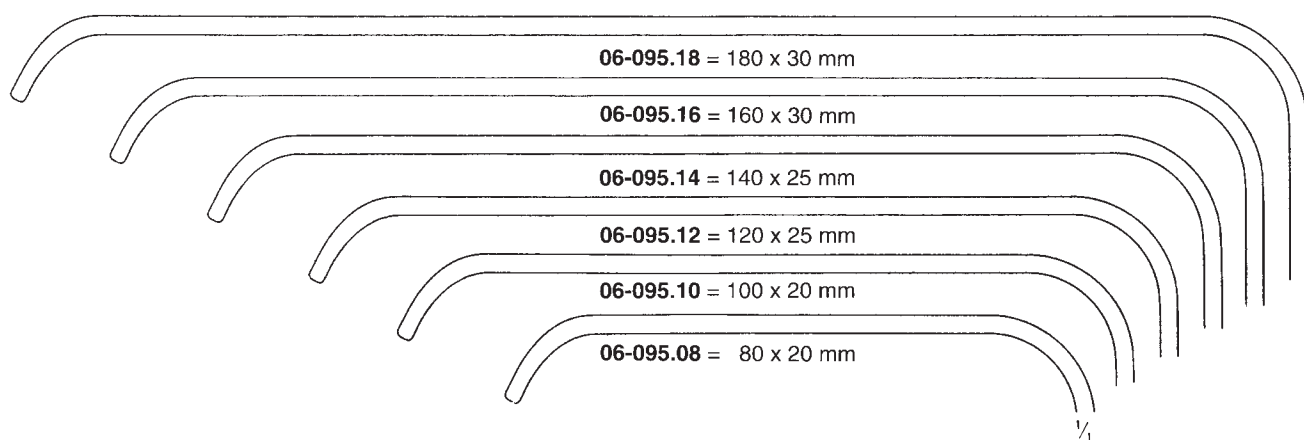

Brunner

25 cm / 10"

**WUNDHAKEN
RETRACTORS**

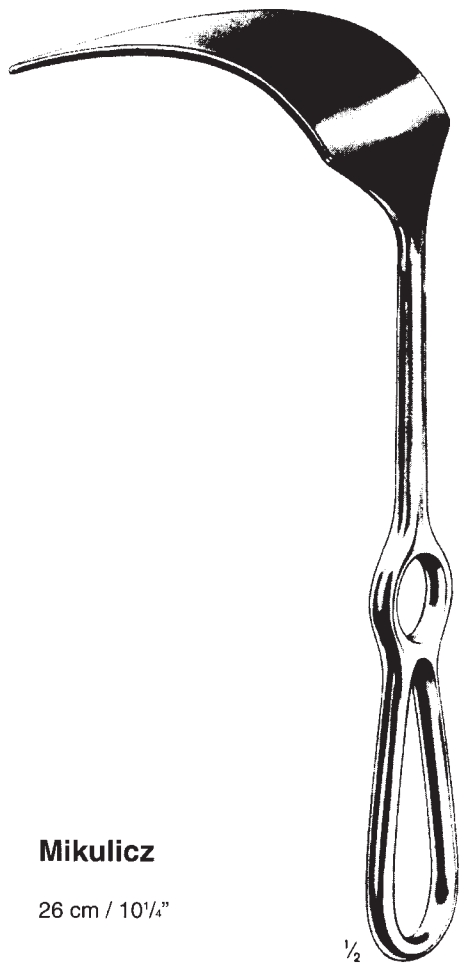
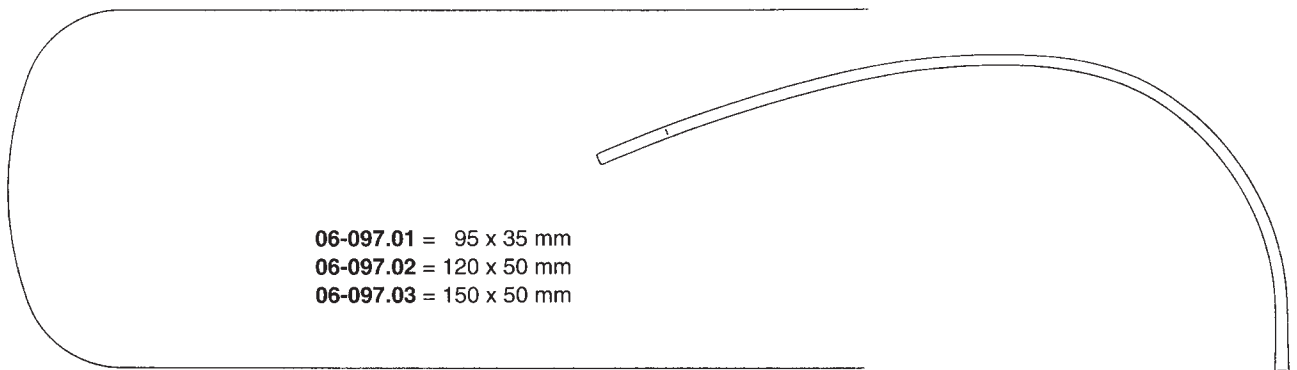

**WUNDHAKEN
RETRACTORS**

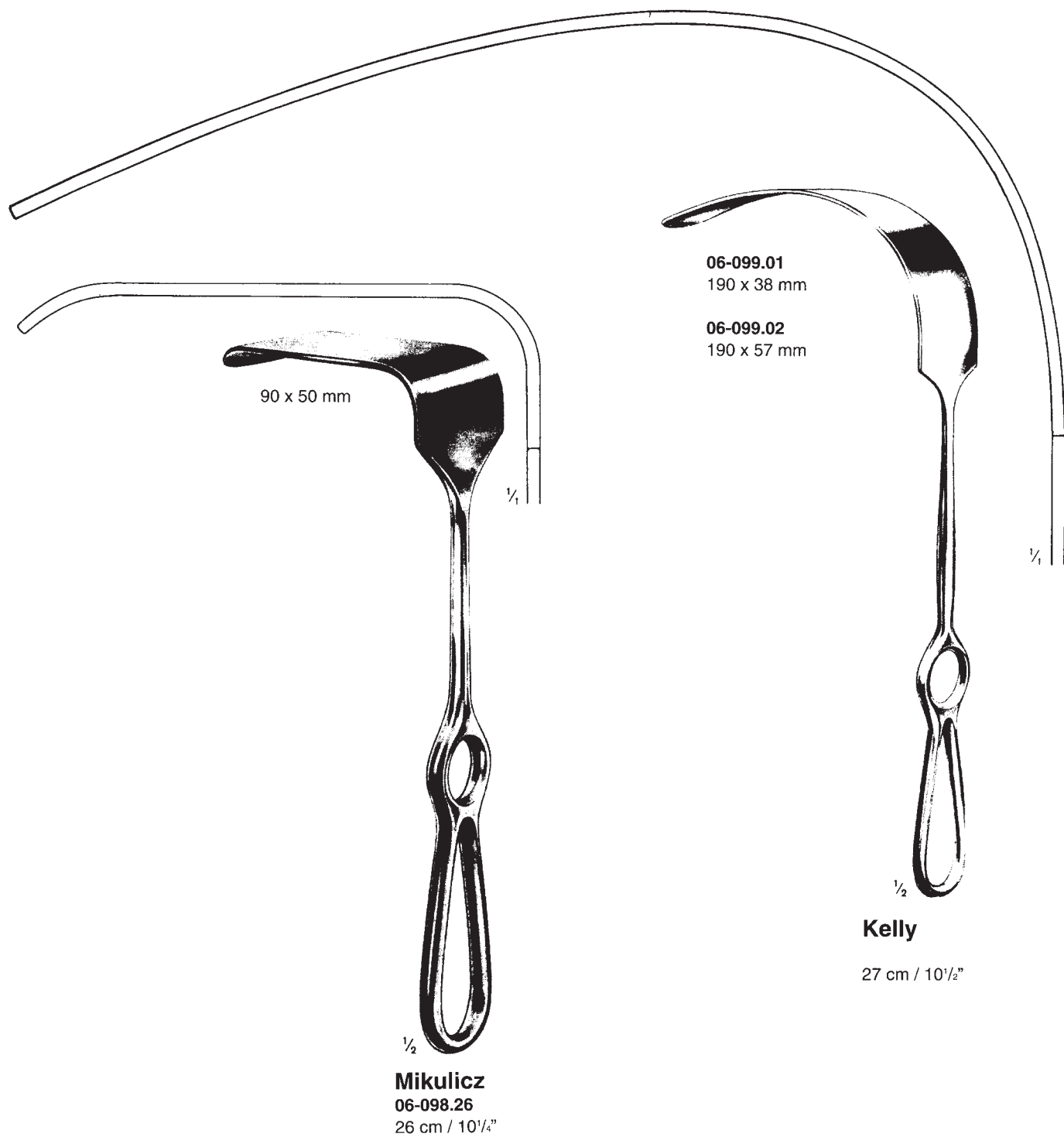

**WUNDHAKEN
RETRACTORS**

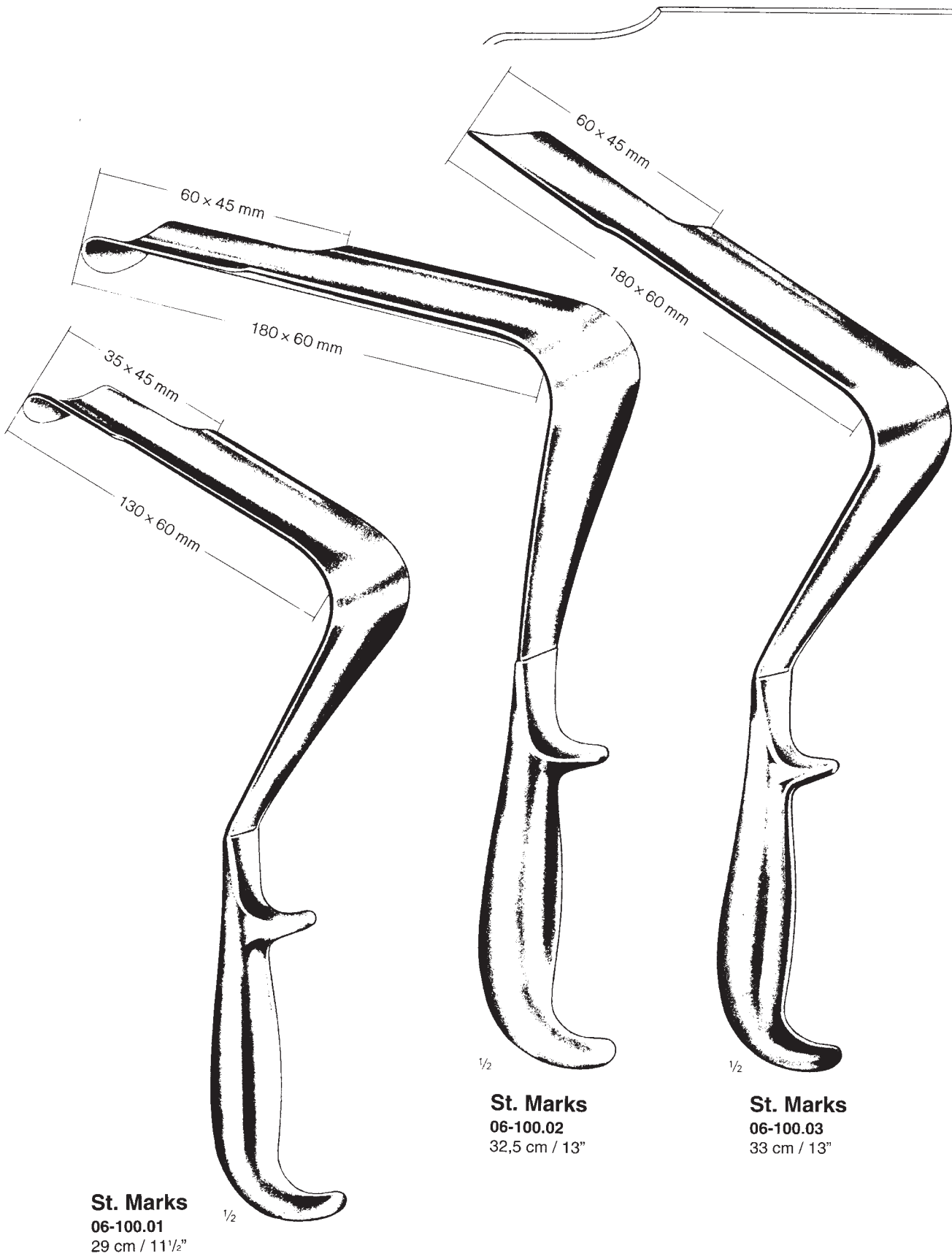

**WUNDHAKEN
RETRACTORS**



Koerte
06-101.28
28 cm / 11"
solid, solide, sólido

**WUNDHAKEN
RETRACTORS**



Fig. 1 = 24 x 20 mm
Fig. 2 = 29 x 26 mm
Fig. 3 = 33 x 29 mm

Fig. 1 = 30 x 28 mm
Fig. 2 = 36 x 36 mm
Fig. 3 = 38 x 43 mm

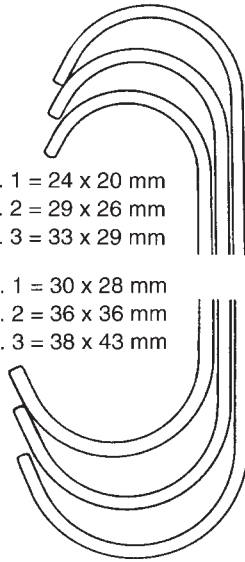

Roux

06-102.00 = set, jeu, juego Fig. 1-3

06-102.01 = Fig. 1 = 14 cm / 5 1/2"

06-102.02 = Fig. 2 = 15 cm / 6"

06-102.03 = Fig. 3 = 17 cm / 6 3/4"

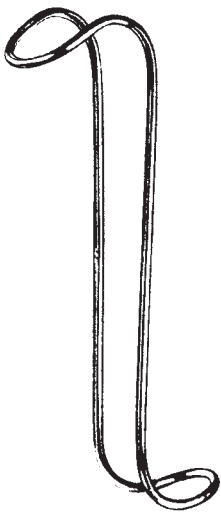

Collin-Hartmann

06-103.01 = 14 cm / 5 1/2" Fig. 1

06-103.02 = 16 cm / 6 1/4" Fig. 2

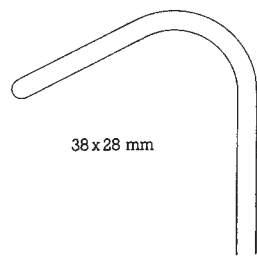

38 x 28 mm

Fig. 1

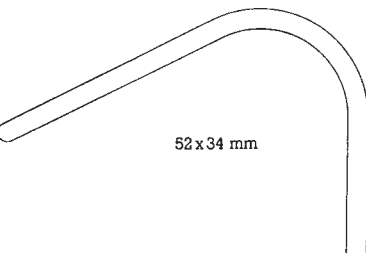

52 x 34 mm

Fig. 2

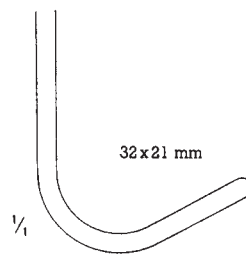

32 x 21 mm

1/1

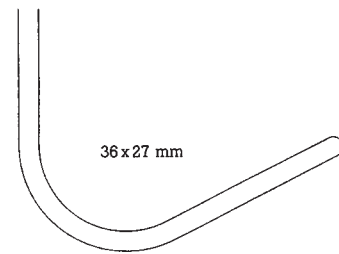

36 x 27 mm

**WUNDHAKEN
RETRACTORS**

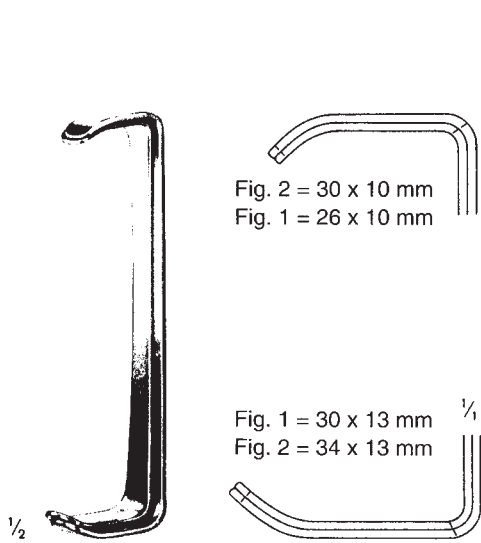

Farabeuf

06-104.00 = set, jeu, juego
12 cm / 4 3/4"

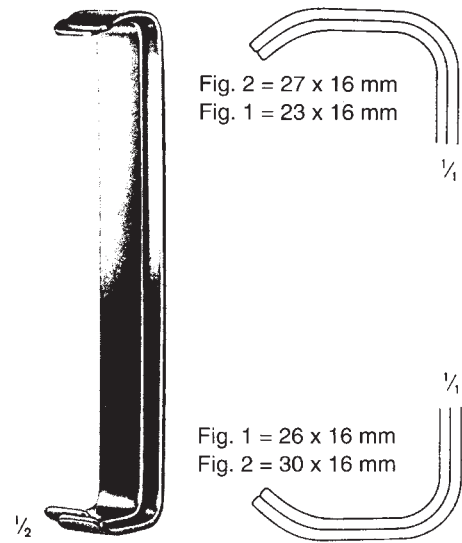

Farabeuf

06-105.00 = set, jeu, juego
15 cm / 5"

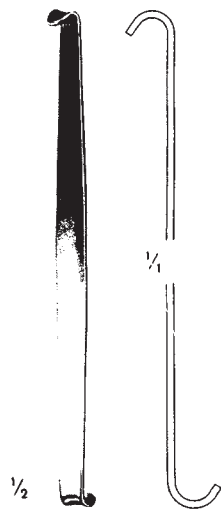

Mini-Roux

06-106.06
14 cm / 5 1/2"

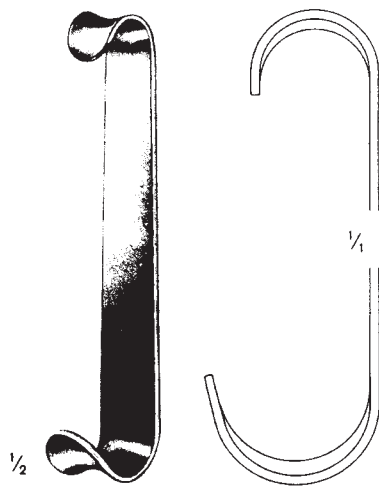

Baby-Roux

06-107.13
13 cm / 5 1/4"

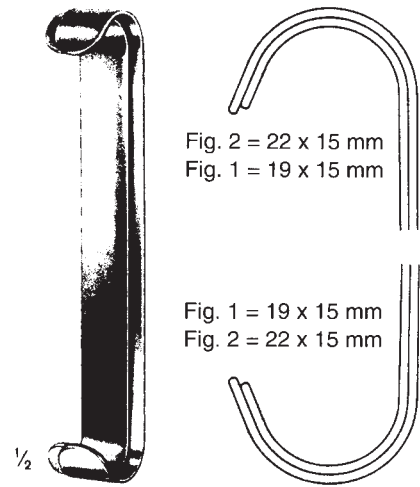

Parker

06-108.01 = set, jeu, juego
13,5 cm / 5 1/4"

**WUNDHAKEN
RETRACTORS**

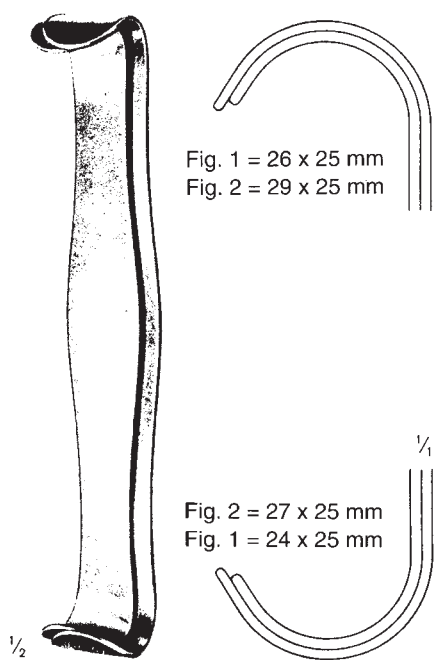

Parker

06-108.02 = set, jeu, juego
18 cm / 7"

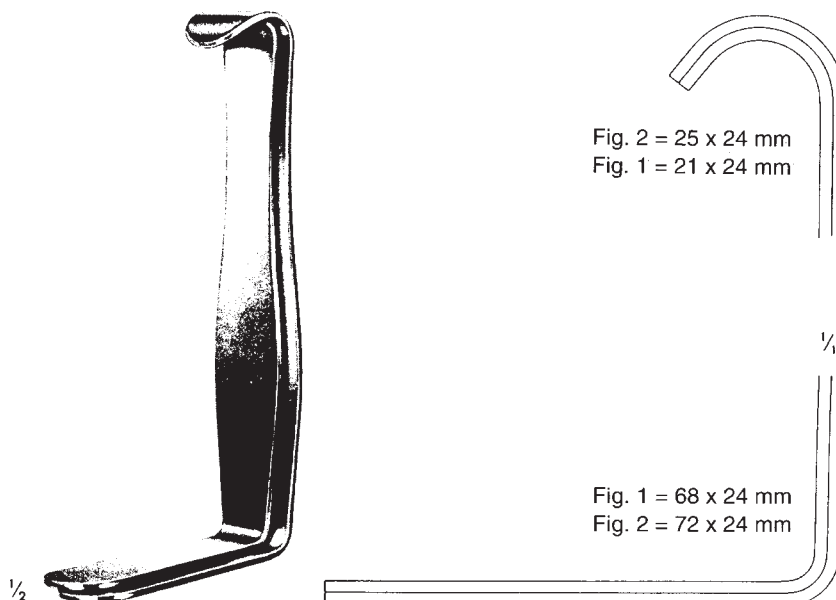

Parker-Mott

06-109.00 = set, jeu, juego
16 cm / 6 1/4"

**WUNDHAKEN
RETRACTORS**

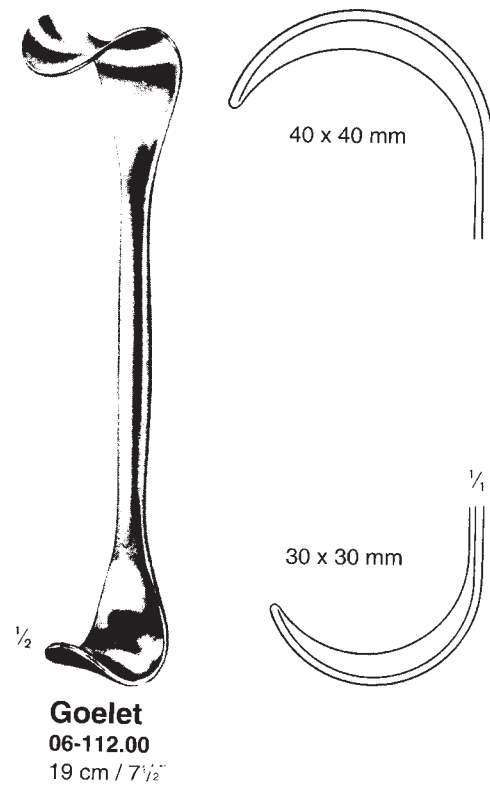
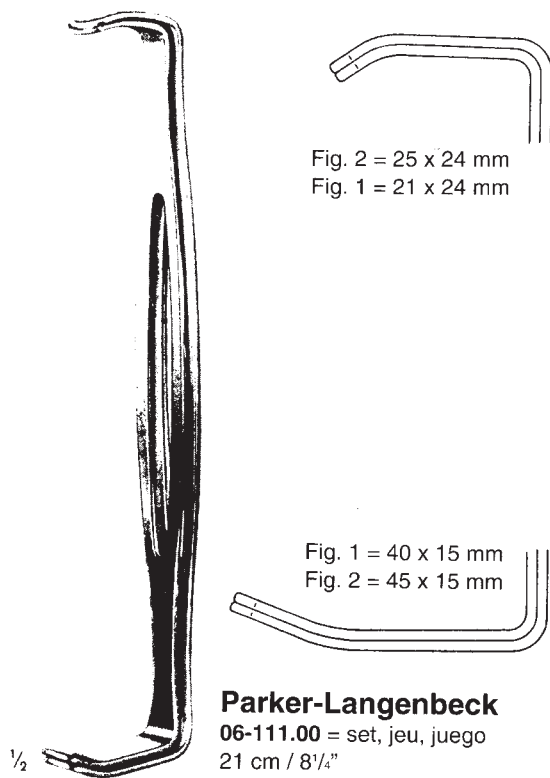
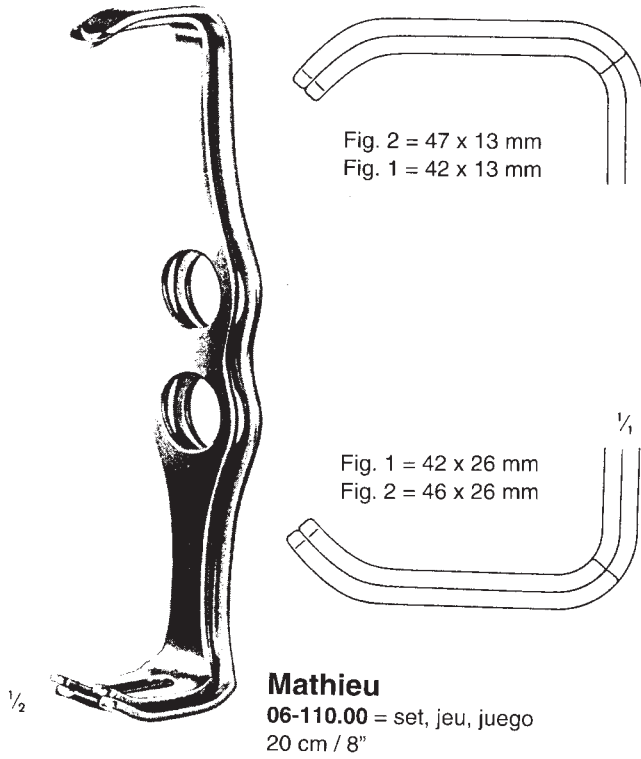

**WUNDHAKEN
RETRACTORS**

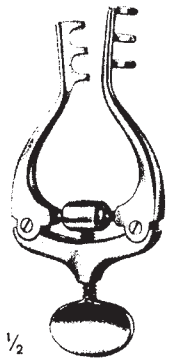

1/2

Jansen

10,5 cm / 4 1/8"

3 x 3 teeth, dents, dentes

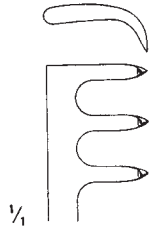

1/4

06-123.10
sharp, pointu,
agudo

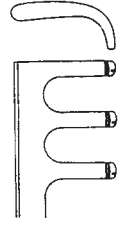

06-124.10
blunt, mousse,
romo

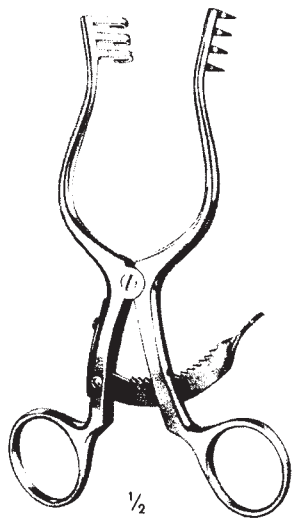

1/2

Scalp Contour

14 cm / 5"

3 x 4 teeth, dents, dentes

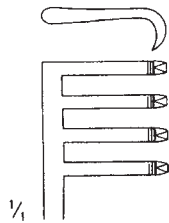

1/4

06-125.14
sharp, pointu,
agudo

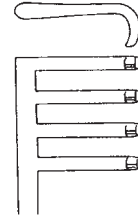

06-126.14
blunt, mousse,
romo

**WUNDHAKEN
RETRACTORS**

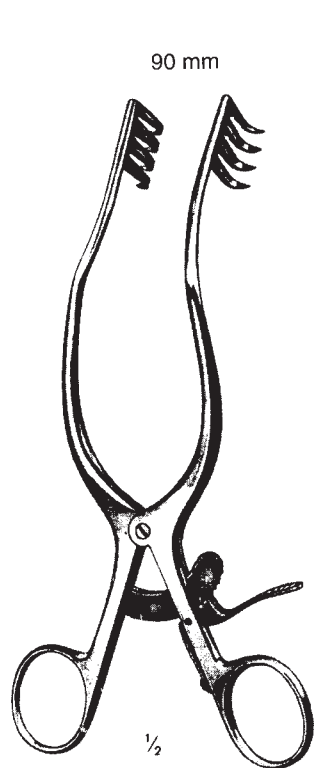

Anderson-Adson

06-127.20
19,5 cm / 8"

4 x 4 teeth, dents, dentes

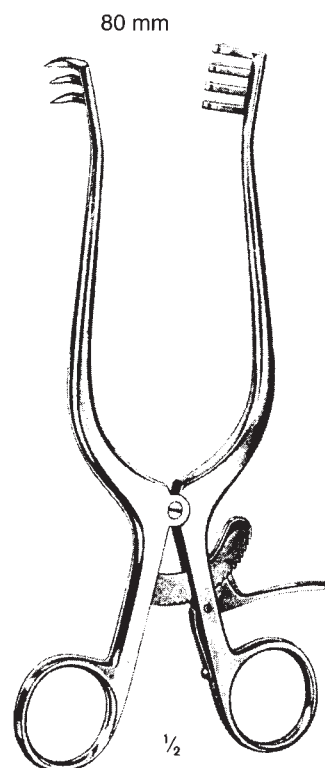

Weitlaner

20 cm / 8"

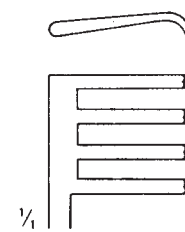

06-128.20
sharp
pointu
agudo

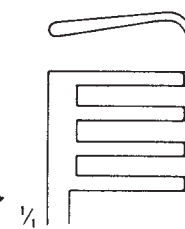

06-129.20
blunt
mousse
romo

**WUNDHAKEN
RETRACTORS**

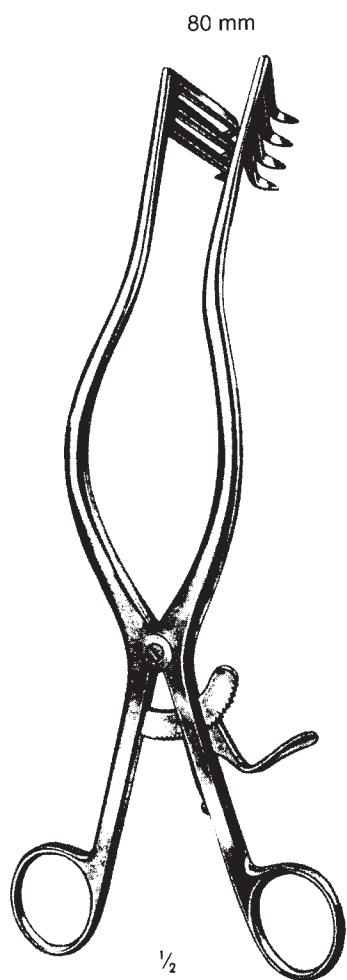

Adson

26,5 cm / 10 1/2"

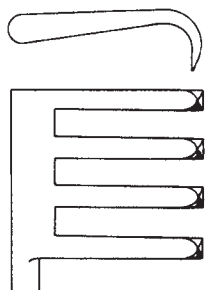

06-130.26
sharp
pointu
agudo
3 x 4 teeth, dents, dentes

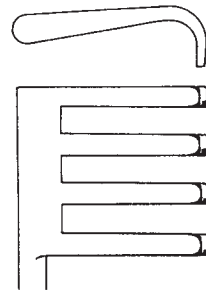

06-131.26
blunt
mousse
romo
3 x 4 teeth, dents, dentes

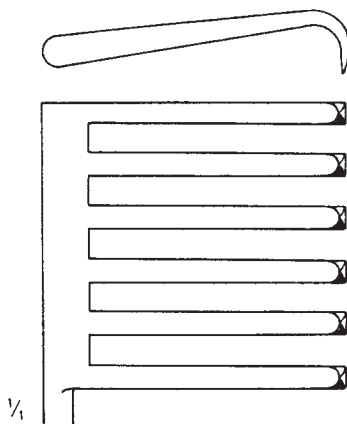

06-132.26
sharp
pointu
agudo
5 x 6 teeth, dents, dentes

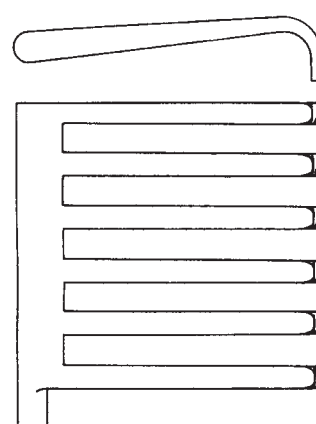

06-133.26
blunt
mousse
romo
5 x 6 teeth, dents, dentes

**WUNDHAKEN
RETRACTORS**

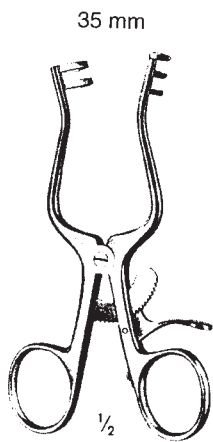

Weitlaner-Loktite

10 cm / 4"

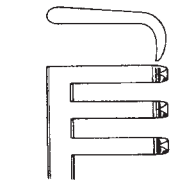

06-134.10
sharp, pointu, agudo
2 x 3 teeth, dents, dentes

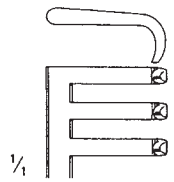

06-135.10
blunt, mousse, romo
2 x 3 teeth, dents, dentes

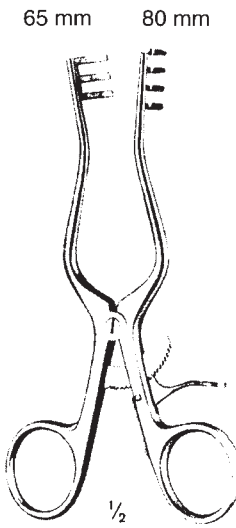

Weitlaner-Wullstein

13 cm / 5 1/2"

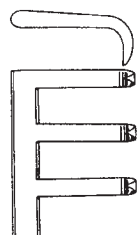

06-138.13
sharp
pointu
agudo

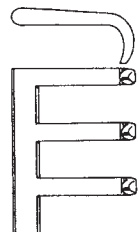

06-139.13
blunt
mousse
romo

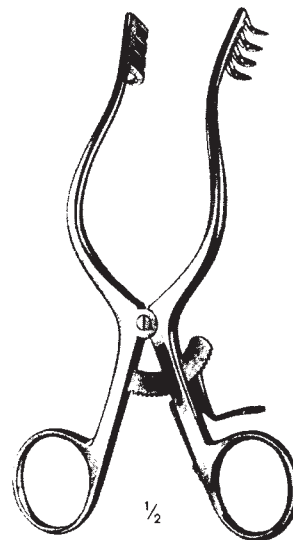

Mollison

06-140.15
15 cm / 6"

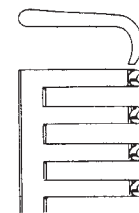

06-136.14 = 14 cm / 5 1/2"
sharp, pointu, agudo
3 x 4 teeth, dents, dentes

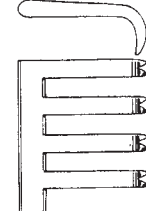

06-136.16 = 16 cm / 6 1/2"
sharp, pointu, agudo
3 x 4 teeth, dents, dents

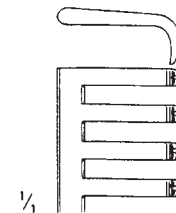

06-137.14 = 14 cm / 5 1/2"
blunt, mousse, romo
3 x 4 teeth, dents, dentes

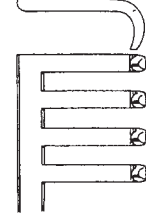

06-137.16 = 16 cm / 6 1/2"
blunt, mousse, romo
3 x 4 teeth, dents, dents

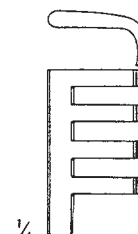

sharp
pointu
agudo

**WUNDHAKEN
RETRACTORS**

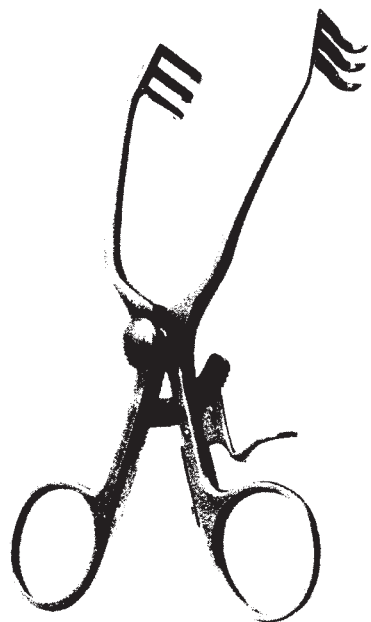

Schuknecht
06-141.13
14 cm / 5"

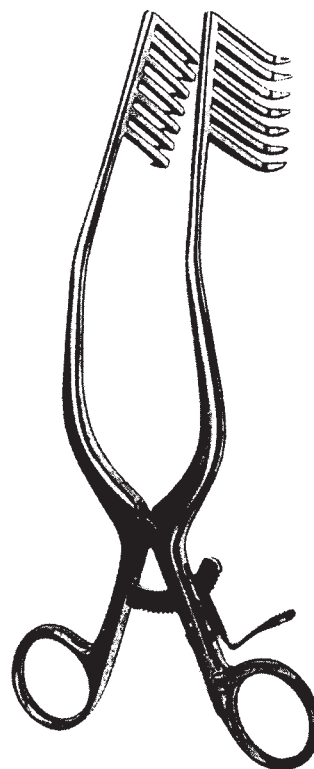

Miskimon
22 cm / 9"
06-113.22 06-114.22
sharp blunt
pointu mousse
agudo romo
7 x 7 teeth, dents, dentes

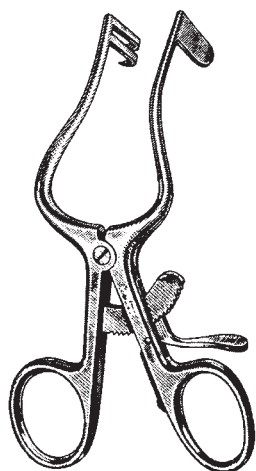

Belucci
10 cm / 4"
06-115.10 06-116.10
left solid blade right solid blade
2 blunt teeth 2 blunt teeth

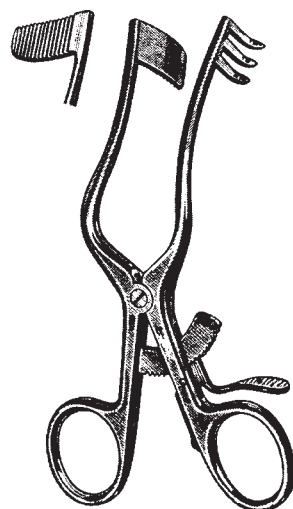

Perkins
14 cm / 5 1/2"
06-117.14 06-118.14
left solid blade right solid blade
3 teeth 3 teeth

**WUNDHAKEN
RETRACTORS**

Hemilaminectomiespreizer
Hemilaminectomy Retractors
Separadores para hemilaminectomia
Ecarteurs pour hémilaminectomie

Blatt links
blade left hand side
valva a la izquierda
valve à gauche

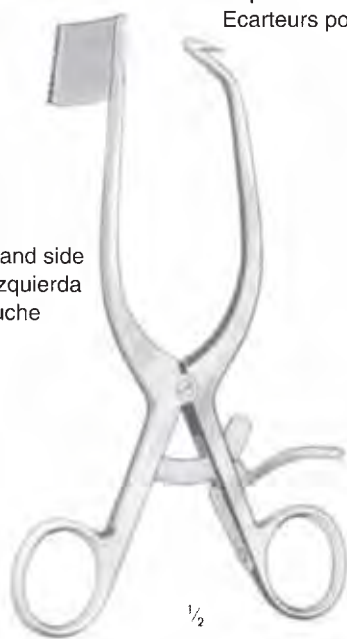

Blatt rechts
blade right hand side
valva a la derecha
valve à droit

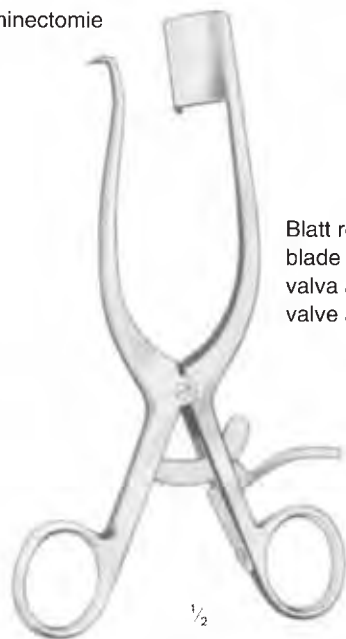

Markham-Meyerding
06-119.01
18 cm / 7"

Markham-Meyerding
06-119.02
18 cm / 7"

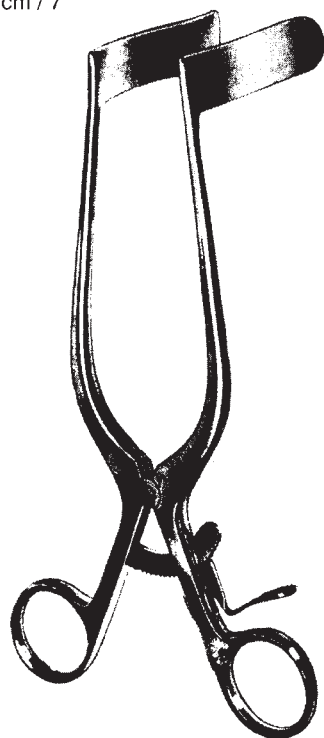

Rigby
06-120.19
19 cm / 7 1/2"

Blätter
Blades 70 mm x 16 mm
valves 2 3/4 x 5/8"
valvas

WUNDHAKEN RETRACTORS

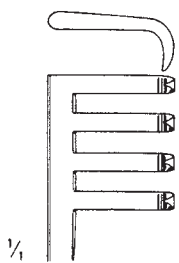

06-142.00
sharp
pointu
agudo

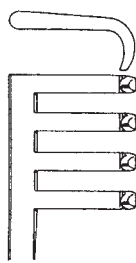

06-143.00
blunt
mousse
romo

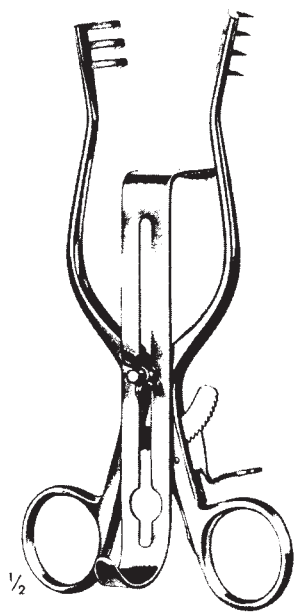

Henley

16,5 cm / 6 1/2"

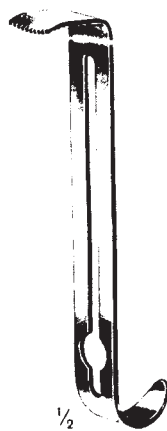

06-143.19
16 mm x 19 mm
5/8" x 3/4"

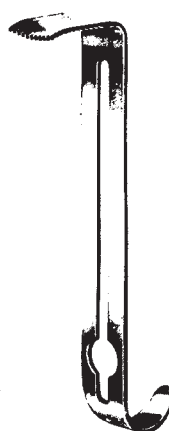

06-143.25
16 mm x 25 mm
5/8" x 1"

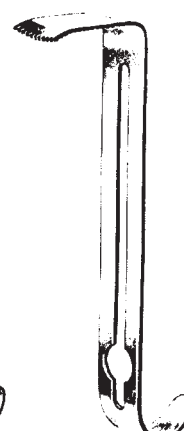

06-143.32
16 mm x 32 mm
5/8" x 1 1/4"

**WUNDHAKEN
RETRACTORS**

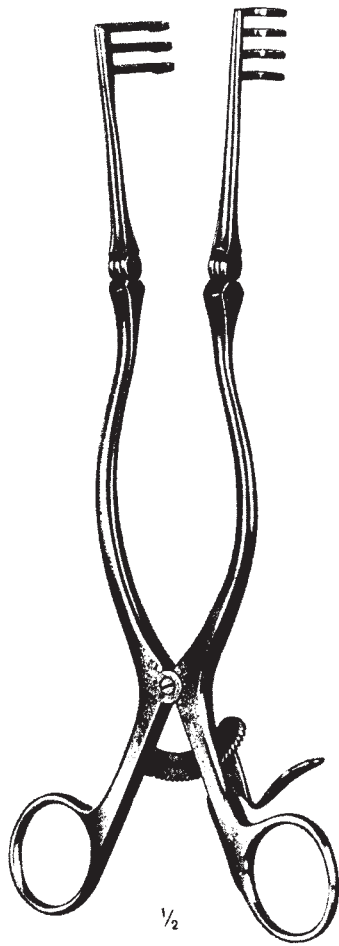

Weitlaner Beckmann

3 x 4 teeth, dents, dentes

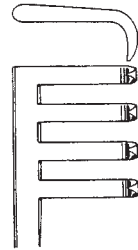

06-144.14

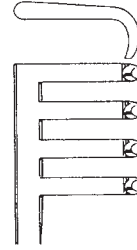

06-145.14

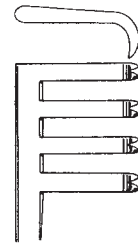

06-144.16

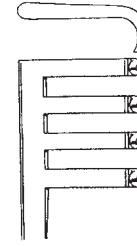

06-145.16

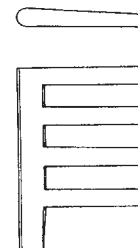

06-144.20

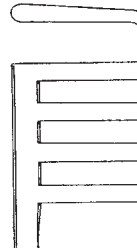

06-145.20

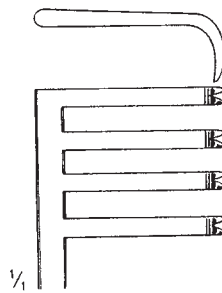

06-144.24

sharp
pointu
agudo

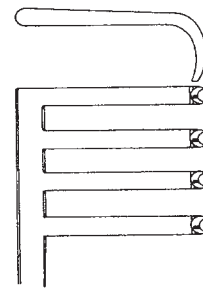

06-145.24

blunt
mousse
romo

**WUNDHAKEN
RETRACTORS**

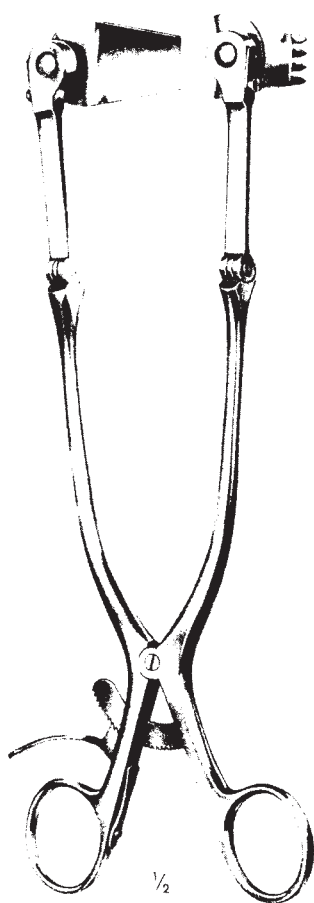

Cloward

06-146.00 complete, with 5 valves
 25 cm / 10" complet avec 5 valves
 completo con 5 valvas

06-146.25 Retractor only
 Ecarteur sans valves
 Separador sin valvas



06-146.40 = 40 mm



06-146.45 = 45 mm



06-146.50 = 50 mm



06-146.55 = 55 mm



06-146.60 = 60 mm

1/4

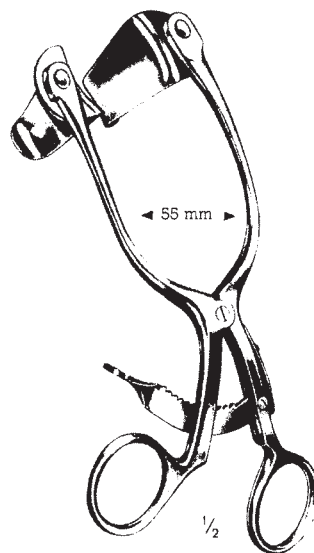

Cloward

06-147.00 complete, with 5 valves
 16 cm / 6 1/2" complet avec 5 valves
 completo con 5 valvas

06-147.16 Retractor only
 Ecarteur sans valves
 Separador sin valvas



06-147.40 = 40 mm



06-147.45 = 45 mm



06-147.50 = 50 mm



06-147.55 = 55 mm



06-147.60 = 60 mm

1/4

**WUNDHAKEN
RETRACTORS**

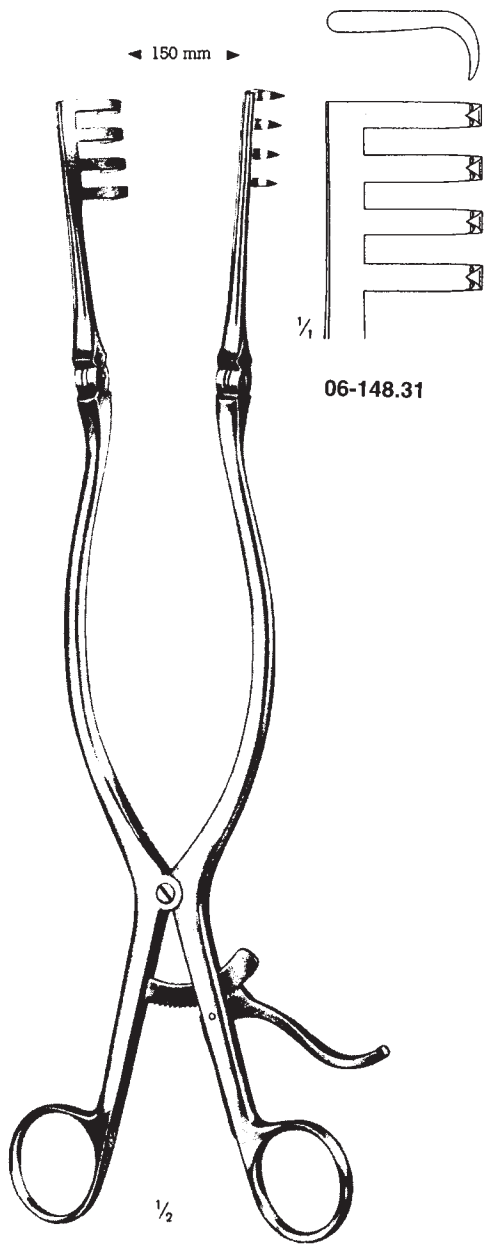

06-148.31

Beckmann Adson

31 cm / 12 1/4"
4 x 4 teeth, dents, dentes

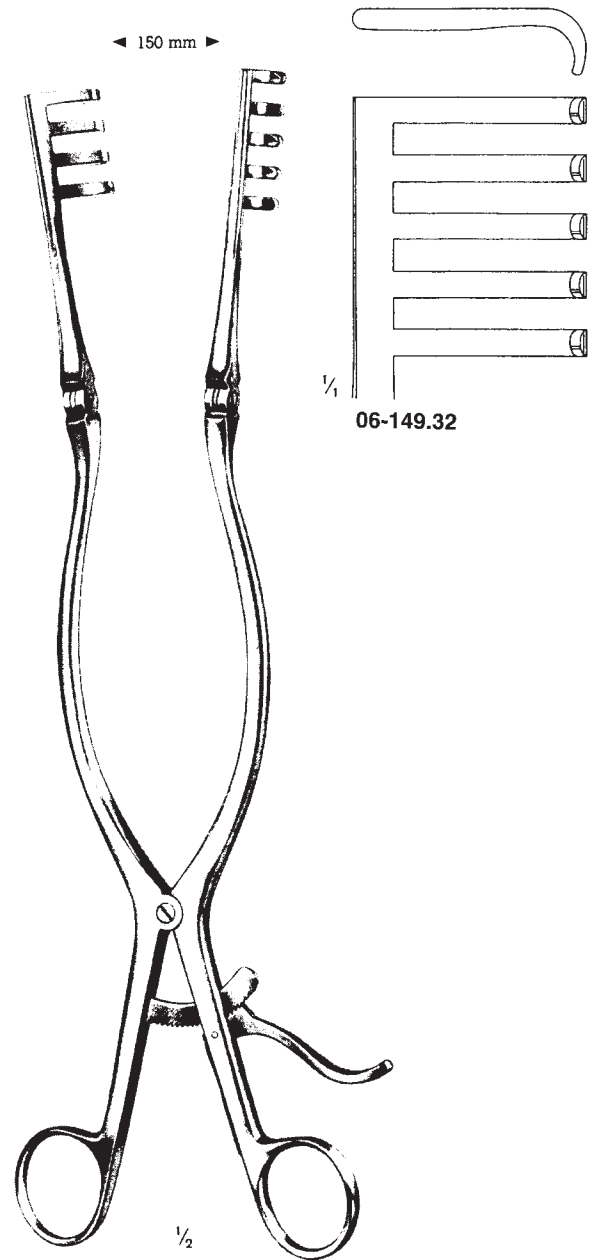

06-149.32

Beckmann Adson

32 cm / 12 1/2"
4 x 5 teeth, dents, dentes

**WUNDHAKEN
RETRACTORS**

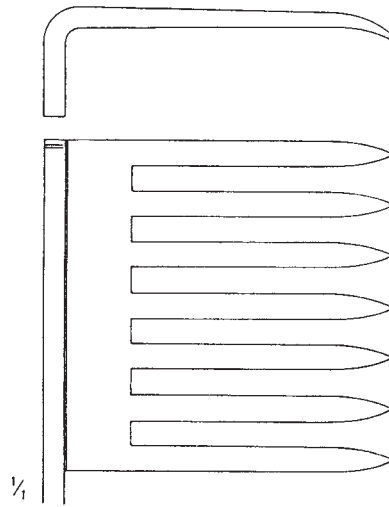
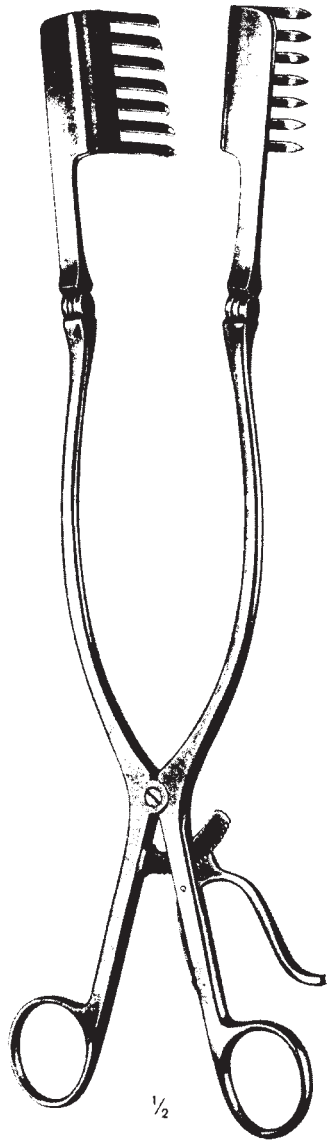

Beckmann-Eaton

06-151.32
32 cm / 12 $\frac{1}{2}$ "

**WUNDHAKEN
RETRACTORS**

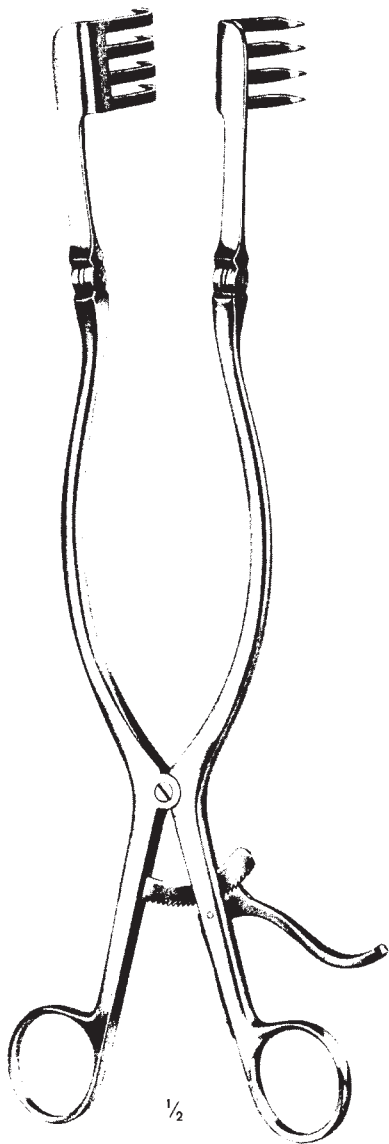

Beckmann-Adson

31 cm / 12 1/4"
4 x 4 teeth, dents, dentes

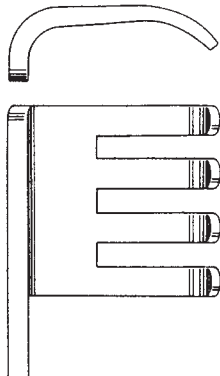

06-150.00

blunt
mousse
romo

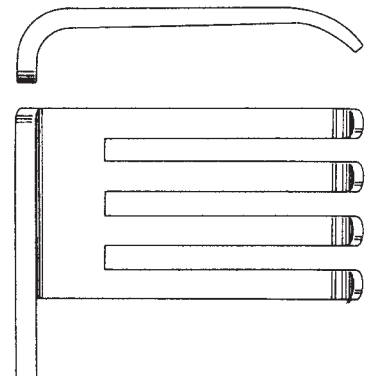

06-150.02

blunt
mousse
romo

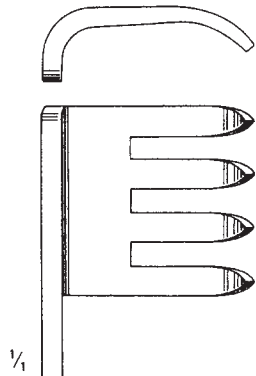

06-150.01

sharp
pointu
agudo

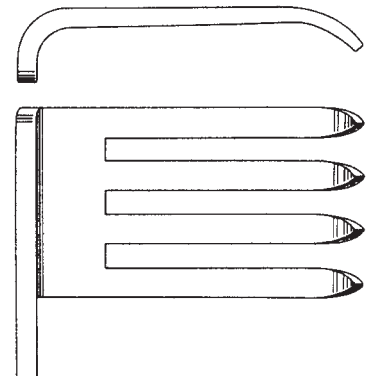

06-150.03

sharp
pointu
agudo

**WUNDHAKEN
RETRACTORS**



CONE

13 cm / 5"
06-151.01 **06-151.02**
 scharf stumpf
 sharp blunt
 agudo romo
 pointu mousse

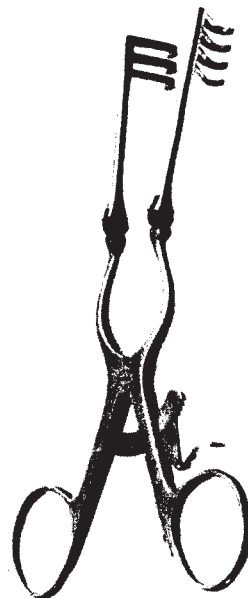

CONE

16,5 cm / 6 1/2"
06-151.03 **06-151.04**
 scharf stumpf
 sharp blunt
 agudo romo
 pointu mousse



CONE

20 cm / 8"
06-151.05 **06-151.06**
 scharf stumpf
 sharp blunt
 agudo romo
 pointu mousse

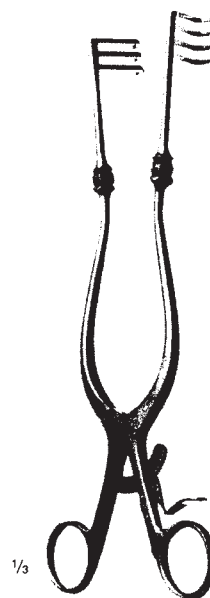

CONE

25 cm / 9 1/2"
06-151.07 **06-151.08**
 scharf stumpf
 sharp blunt
 agudo romo
 pointu mousse

**WUNDHAKEN
RETRACTORS**

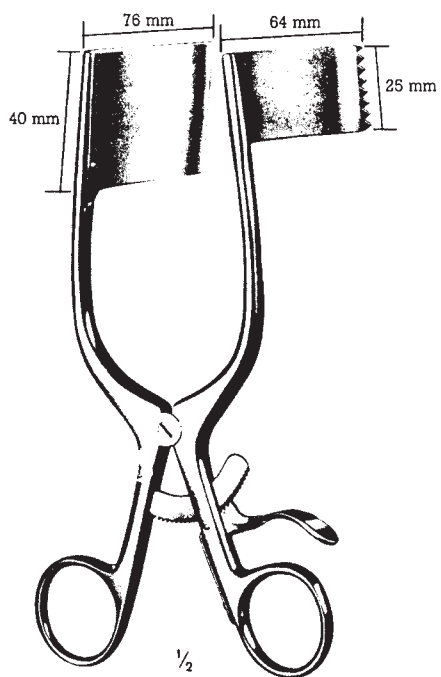

Darling

06-152.01
18 cm / 7"
(Poplitea)

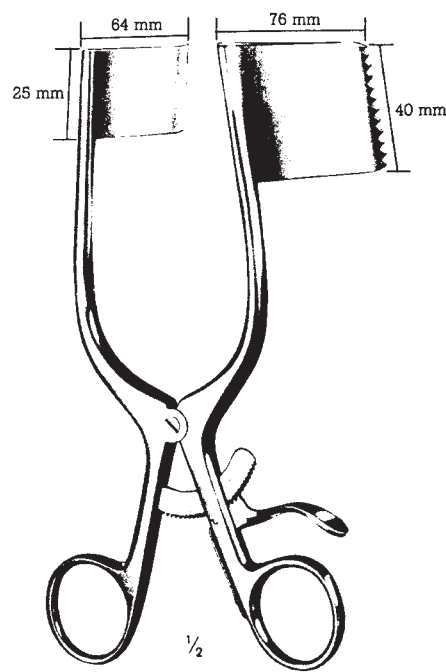

Darling

06-152.02
18 cm / 7"
(Poplitea)

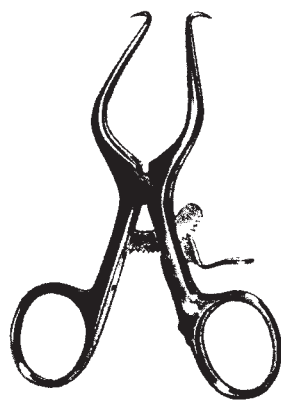

GELPI

06-153.09
9 cm / 3 1/2"

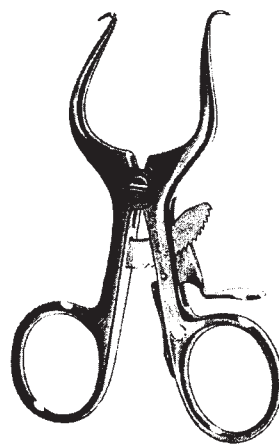

GELPI

06-153.11
11 cm / 4 1/2"

**WUNDHAKEN
RETRACTORS**

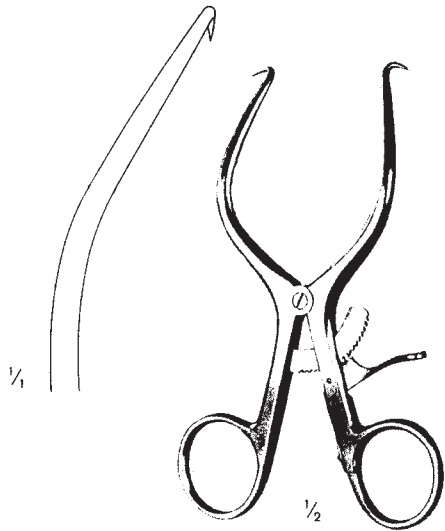

Gelpi

06-153.13
13 cm / 5"

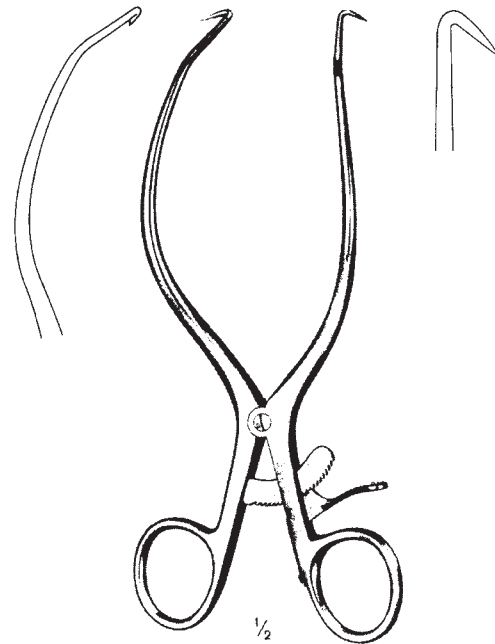

Gelpi

06-153.18
18 cm / 7"

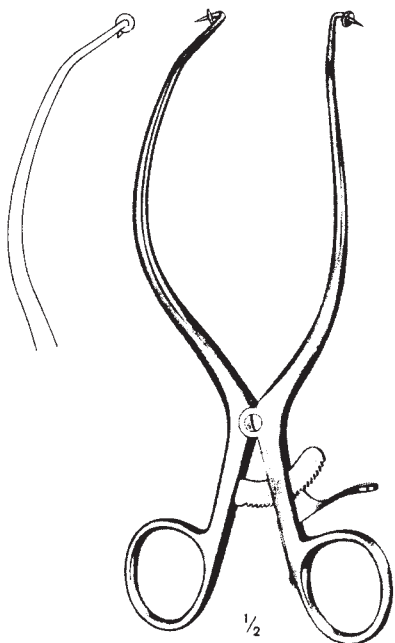

Gelpi

06-154.18
18 cm / 7"

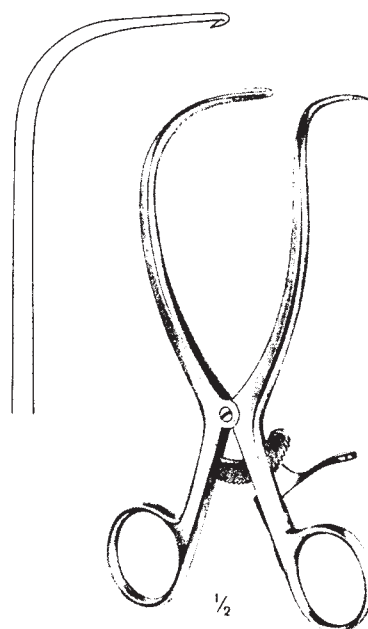

Gelpi

06-155.15
15 cm / 6"

**WUNDHAKEN
 RETRACTORS**
**ABDOMINAL RETRACTORS
 ECARTEURS A PAROI ABDOMINALE
 SEPARADORES ABDOMINALES**
COLLIN

06-156.01	32 mm x 62 mm 1 1/2" x 2 3/8"	55 mm x 55 mm 2 1/8" x 2 1/8"
06-156.02	38 mm x 80 mm 1 1/2" x 3 1/8"	55 mm x 65 mm 2 1/8" x 2 1/2"
06-156.03	38 mm x 100 mm 1 1/2" x 4"	55 mm x 75 mm 2 1/8" x 2"
	seitl. Valven lateral blades valvas laterales valves latérales	Mittelvalve center blade valva central valve centrale

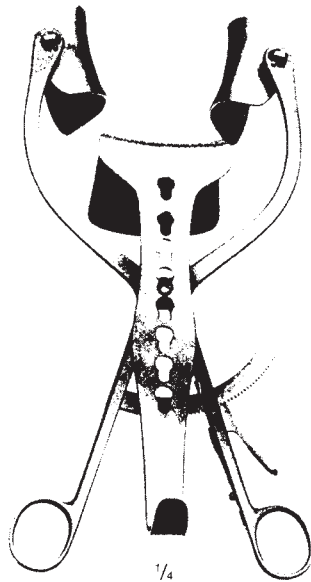
COLLIN

06-157.01	50 mm x 58 mm 2" x 2 1/4"	62 mm x 67 mm 2 1/2" x 2 5/8"
06-157.02	62 mm x 80 mm 2 3/8" x 3 1/8"	62 mm x 70 mm 2 1/2" x 2 3/4"
	seitl. Valven lateral blades valvas laterales valves latérales	Mittelvalve center blade valva central valve centrale

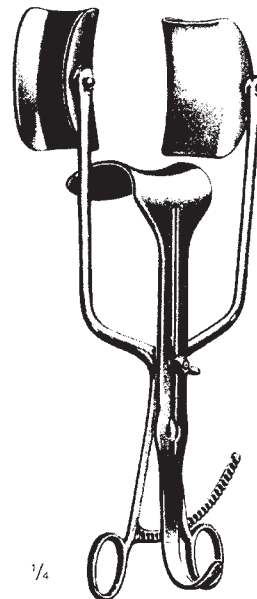
OETTINGEN

06-158.01	38 mm x 80 mm 1 1/2" x 3 1/8"	50 mm x 65 mm 2" x 2 1/2"
	seitl. Valven lateral blades valvas laterales valves latérales	Mittelvalve center blade valva central valve centrale

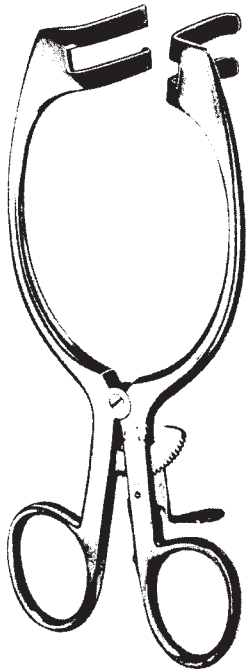
**WUNDHAKEN
 RETRACTORS**
**ABDOMINAL RETRACTOR
 ECARTEURS A PAROI ABDOMINALE
 SEPARADORES ABDOMINALES**

Mayo Adams 17 cm / 6³/₄"

06-159.17 ohne Mittelvalve
 without center blade
 sans valve centrale
 sin valva central

65 mm / 2¹/₂" Spreizweite
 blade opening
 écartement
 abertura de la hoja

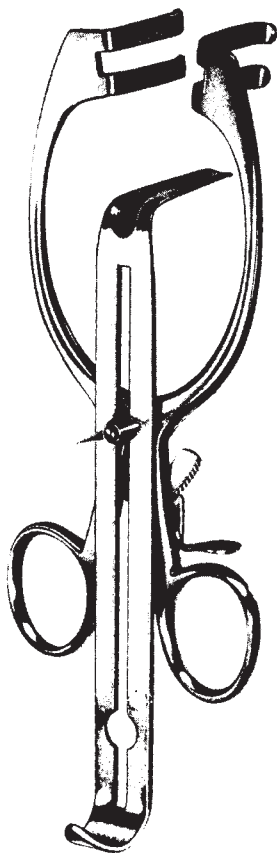

Mayo Adams 17 cm / 6³/₄"

06-160.17 mit Mittelvalve
 with center blade
 avec valve centrale
 con valva central

65 mm / 2¹/₂" Spreizweite
 blade opening
 écartement
 abertura de la hoja

**WUNDHAKEN
RETRACTORS**

**ABDOMINAL RETRACTORS
ECARTEURS A PAROI ABDOMINALE
SEPARADORES ABDOMINALES**



BALFOUR-BABY 06-161.01

27 mm x 25 mm	25 mm x 25 mm	9 cm
1 ¹ / ₁₆ " x 1"	1" x 1"	3 ¹ / ₂ "
seitl. Valven	Mittelvalve	Spreizweite
lateral blades	center blade	spread
valvas laterales	valva central	abertura de la hoja
valves latérales	valve centrale	écartement

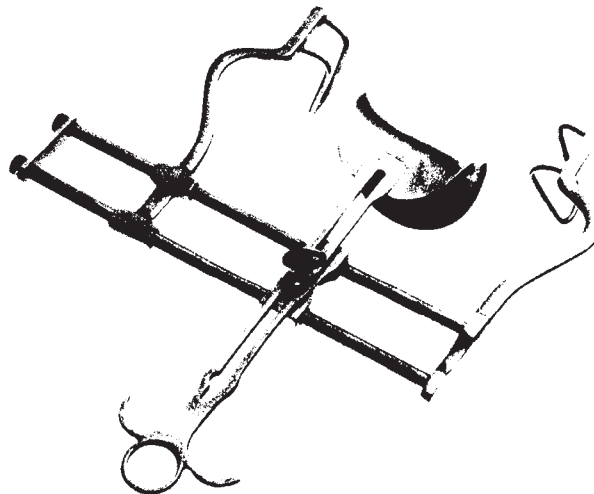

BALFOUR

06-161.02	58 mm	45 mm x 80 mm	125 mm
06-161.03	60 mm	60 mm x 80 mm	200 mm
06-161.04	90 mm	80 mm x 80 mm	220 mm
	seitl. Valven	Mittelvalve	Spreizweite
	lateral blades	center blade	spread
	valvas laterales	valva central	abertura de la hoja
	valves latérales	valve centrale	écartement

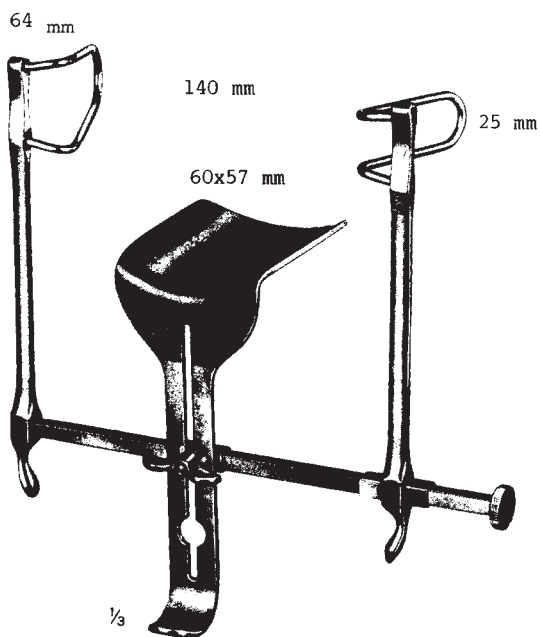

Gosset
06-162.00

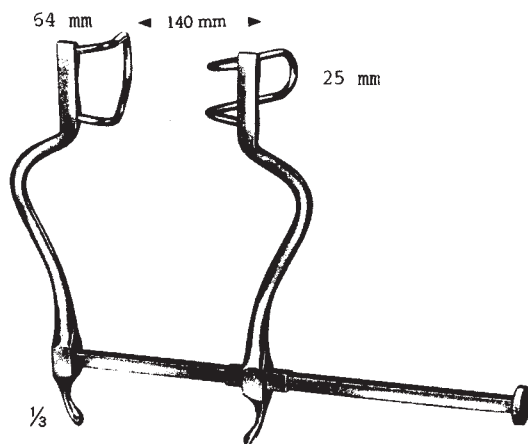

Gosset
06-163.00

**WUNDHAKEN
RETRACTORS**

**LAMINECTOMY RETRACTORS
ECARTEURS POUR LAMINECTOMIE
SEPARADORES PARA LAMINECTOMIA**

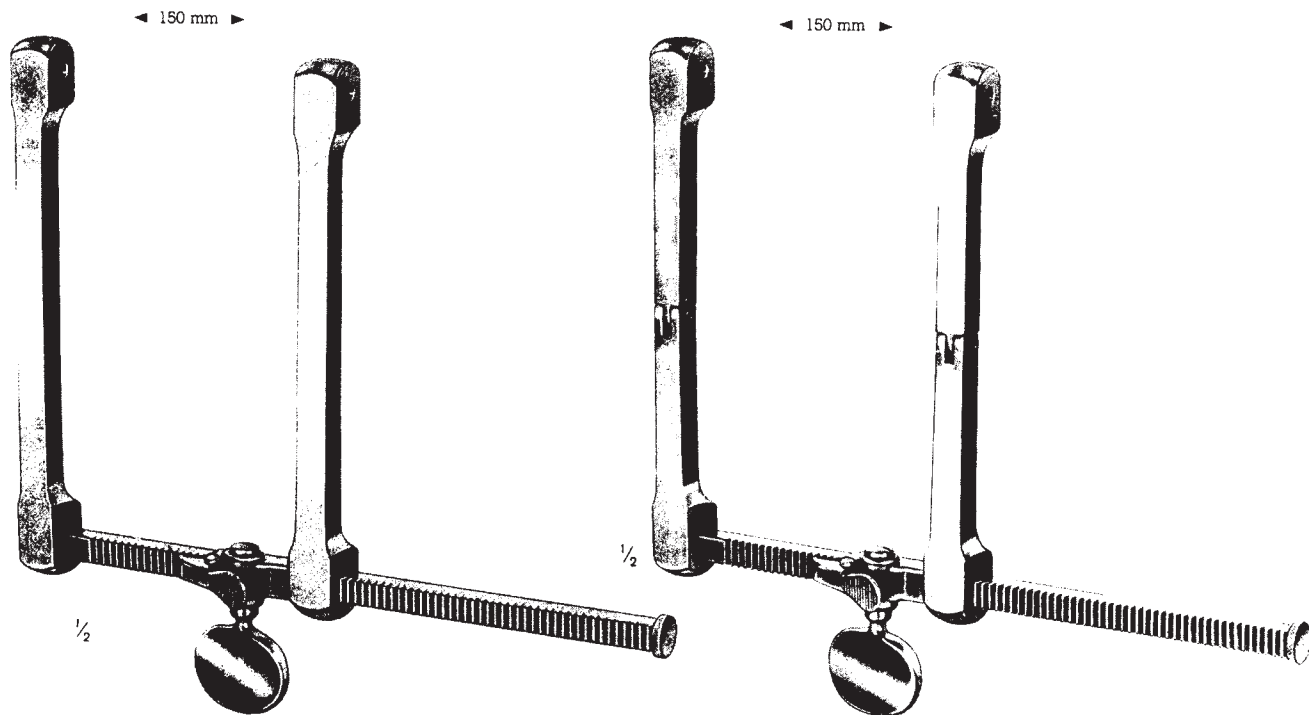

Scoville
06-164.00

Scoville-Haverfield
06-164.50

**WUNDHAKEN
RETRACTORS**

**LAMINECTOMY RETRACTORS
ECARTEURS POUR LAMINECTOMIE
SEPARADORES PARA LAMINECTOMIA**

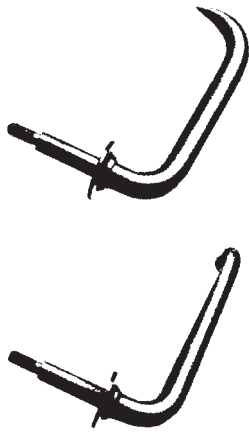

1/2

Scoville

spitz, sharp, agudo, pointu
06-165.01 50 mm **06-165.02** 60 mm
06-165.03 70 mm **06-165.04** 75 mm

stumpf, blunt, romo, mousse
06-166.01 50 mm **06-166.02** 60 mm
06-166.03 70 mm **06-166.04** 75 mm

tief, deep,
 profundidad, profondeur

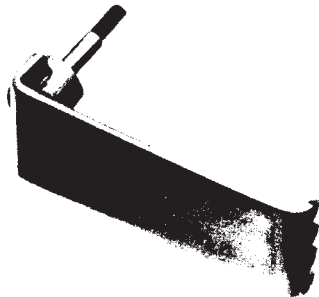

2/3

Scoville

tief	breit
deep	wide
profundidad	anchura
profondeur	largeur
06-167.01	50 mm, 2" 25 mm, 1"
06-167.02	50 mm, 2" 50 mm, 2"
06-167.03	57 mm, 2 1/4" 25 mm, 1"
06-167.04	57 mm, 2 1/4" 38 mm, 1 1/2"
06-167.05	64 mm, 2 1/2" 25 mm, 1"
06-167.06	64 mm, 2 1/2" 29 mm, 1 1/8"
06-167.07	64 mm, 2 1/2" 50 mm, 2"
06-167.08	67 mm, 2 5/8" 28 mm, 1 1/8"
06-167.09	67 mm, 2 5/8" 30 mm, 1 3/16"
06-167.10	75 mm, 3" 25 mm, 1"
06-167.11	75 mm, 3" 50 mm, 2"
06-167.12	88 mm, 3 1/2" 25 mm, 1"
06-167.13	100 mm, 4" 50 mm, 2"



1/2

Taylor

tief	breit
deep	wide
profundidad	anchura
profondeur	largeur
06-168.01	48 mm, 1 7/8" 50 mm, 2"
06-168.02	64 mm, 2 1/2" 50 mm, 2"
06-168.03	64 mm, 2 1/2" 64 mm, 2 1/2"
06-168.04	80 mm, 3 1/8" 57 mm, 2 1/4"

Scoville

06-169.01	41 mm, 1 5/8" 38 mm, 1 1/2"
06-169.02	67 mm, 2 5/8" 44 mm, 1 3/4"

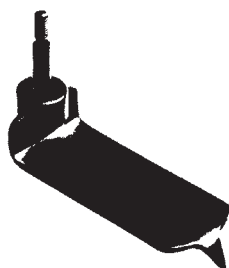

1/2

Taylor

tief	breit
deep	wide
profundidad	anchura
profondeur	largeur
06-170.01	75 mm, 3" 32 mm, 1 1/4"
06-170.02	100 mm, 4" 42 mm, 1 5/8"



1/2

Taylor

tief	breit
deep	wide
profundidad	anchura
profondeur	largeur
06-171.01	25 mm, 1" 41 mm, 1 5/8"
06-171.02	44 mm, 1 3/4" 38 mm, 1 1/2"
06-171.03	50 mm, 2" 41 mm, 1 5/8"

WUNDHAKEN RETRACTORS

LAMINECTOMY RETRACTORS ECARTEURS POUR LAMINECTOMIE SEPARADORES PARA LAMINECTOMIA

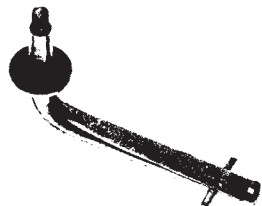

1/2

Scoville

tief
deep
profondeur
profundidad

06-184.05	38 mm, 1 1/2"
06-185.05	50 mm, 2"
06-186.05	70 mm, 2 3/4"
06-187.05	75 mm, 3"

with stop
avec stop
con alto



2/3

Hibbs

06-188.04	50 mm, 2"	19 mm, 3/4"
06-188.05	50 mm, 2"	25 mm, 1"
06-188.06	50 mm, 2"	50 mm, 2"
06-188.07	64 mm, 2 1/2"	25 mm, 1"
06-188.08	64 mm, 2 1/2"	38 mm, 1 1/2"
06-188.09	75 mm, 3"	25 mm, 1"
06-188.10	75 mm, 3"	38 mm, 1 1/2"
06-188.11	75 mm, 3"	50 mm, 1"
06-188.12	75 mm, 3"	64 mm, 2 1/2"
06-188.13	88 mm, 3 1/2"	25 mm, 1"
06-188.14	88 mm, 3 1/2"	38 mm, 1 1/2"
06-188.15	100 mm, 4"	25 mm, 1"
06-188.16	100 mm, 4"	50 mm, 2"

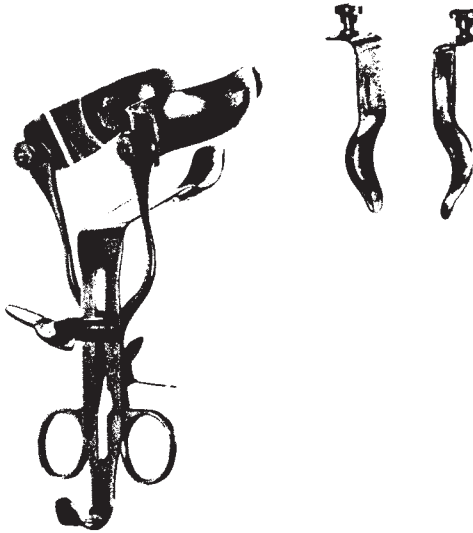
**WUNDHAKEN
 RETRACTORS**
**RECTAL SPECULUM
 SPECULUM POUR LE RECTUM
 ESPCULOS RECTULES**

Alan-Parks
 $\frac{1}{2}$
06-193.00

 13,5 cm, 5 $\frac{1}{4}$ "

bestehend aus / consisting of / compuesto de / comprenant:

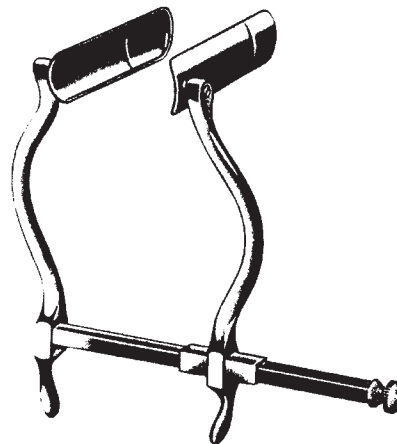
1 Rahmen, frame, cuadro, cadre	
2 Valven, blades, valvas, valves	75 mm x 24 mm
2 Valven, blades, valvas, valves	95 mm x 24 mm
1 Valve, blade, valva, valve	95 mm x 24 mm

 $\frac{1}{3}$
Smith-Buie
06-194.00

 70 mm x 22 mm, 2 $\frac{3}{4}$ " x $\frac{7}{8}$ "

Spreizweite

blade opening

abertura de la hoja

écartement

 125 mm, 4 $\frac{7}{8}$ "

**WUNDHAKEN
RETRACTORS**

**BLADDER RETRACTOR
ECARTEUR VESICALES
SEPARADORES VESICALES**

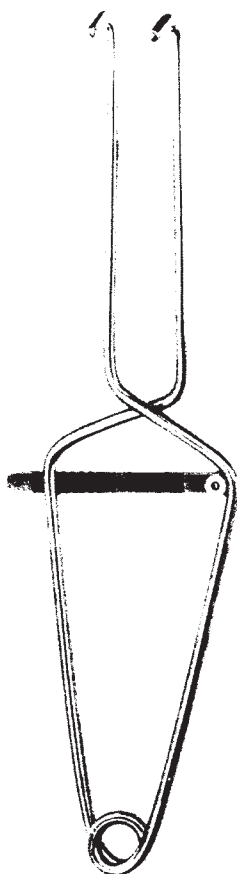

MILLIN

06-196.28
28,5 cm / 11 1/4"



MILLIN

1/3

06-195.00

bestehend aus / consisting of / compuesto de / comprenant:

- | | |
|----------------------------------|----------------|
| 1 Rahmen, frame, cuadro, cadre | |
| 2 Valven, blades, valvas, valves | 57 mm x 25 mm |
| 2 Valven, blades, valvas, valves | 80 mm x 25 mm |
| 1 Valve, blade, valva, valve | 120 mm x 45 mm |

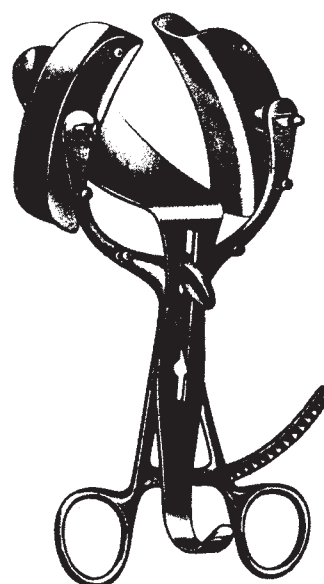

LEGUE

1/2

06-197.00

- | | |
|------------------|-----------------|
| 28 mm x 60 mm | 70 mm x 32 mm |
| 1 1/8" x 2 3/8" | 2 3/4" x 1 1/4" |
| seitl. Valven | Mittelvalve |
| lateral blades | center blade |
| valvas laterales | valva central |
| valves latérales | valve centrale |

**WUNDHAKEN
 RETRACTORS**

1/6

Rochard
06-198.01

Befestigungsrahmen für OP-Tische
 Mounting frame for operating tables
 Dispositivo de fijación para mesas de operaciones
 Dispositif de fixation pour tables d'opération



1/3

Rochard
06-198.02

19 cm / 7³/₄"
 Fixiervorrichtung
 Fixation device
 Dispositivo de fijación
 Compas articulé

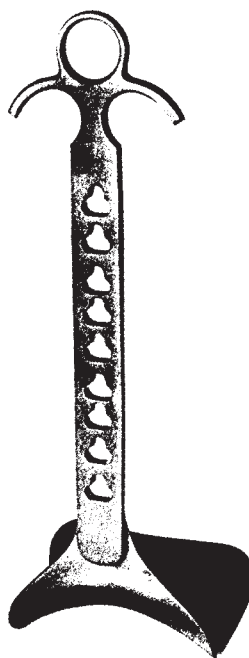

1/3

Rochard 27 cm / 10¹/₂"

06-205.01 50 mm x 95 mm, 2" x 3³/₄"
06-205.02 50 mm x 105 mm, 2" x 4¹/₈"
06-205.03 60 mm x 120 mm, 2³/₈" x 4³/₄"
06-205.04 60 mm x 135 mm, 2³/₈" x 5¹/₄"
06-205.05 60 mm x 155 mm, 2³/₈" x 6¹/₈"

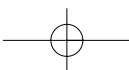
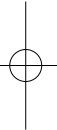
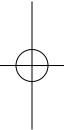
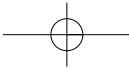



**HOHLMESSEL- UND KNOCHENSPLITTERZANGEN
BON RONGEURS — BONE CUTTING FORCEPS**

**DRAHT- UND BOLZENSCHNEIDER
WIRE CUTTING — PLIES-PIN CUTTER**

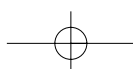
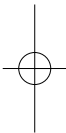
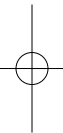
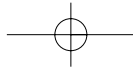

**HOHLMEISSEL- UND KNOCHENSPLITTERZANGEN
BON RONGEURS — BONE CUTTING FORCEPS**



Böhler, 15 cm, 6"
10-100.03 - 10-101.05



gerade/straight



gebogen/curved

3 mm	10-100.03	10-101.03
4 mm	10-100.04	10-101.04
5 mm	10-100.05	10-101.05



Kleinert-Kutz, 15 cm, 6"
10-196.02 - 10-200.03



10-196.02
leicht gebogen
slightly curved
2 x 13 mm



10-200.03
stark gebogen
full curved
3 x 8 mm

**HOHLMEISSEL- UND KNOCHENSPLITTERZANGEN
BON RONGEURS — BONE CUTTING FORCEPS**

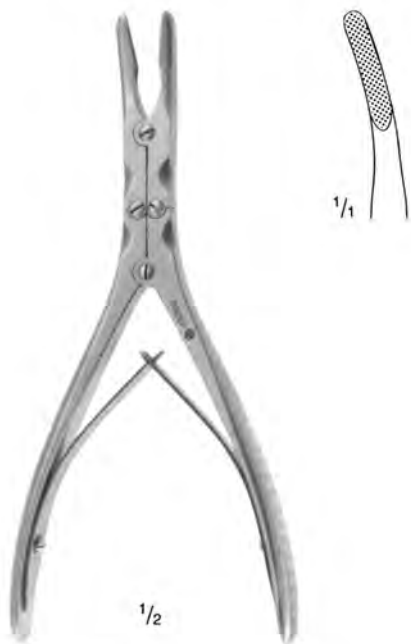

$\frac{1}{2}$
Beyer
18 cm, 7"
10-102.18

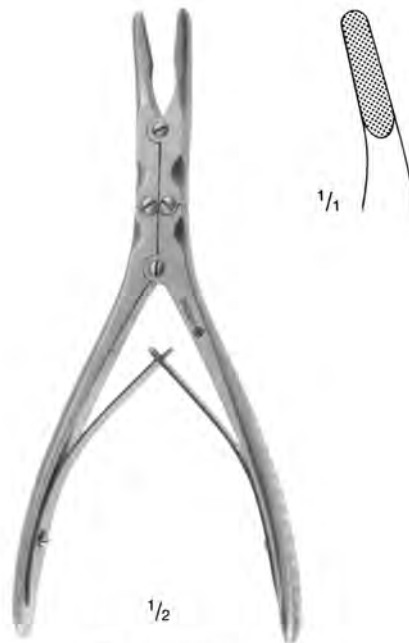

$\frac{1}{2}$
Zaufal-Jansen
18 cm, 7"
10-103.18



$\frac{1}{2}$
Mayfield
17 cm, 6 $\frac{3}{4}$ "
10-204.17



$\frac{1}{2}$
Marquardt
20 cm, 8"
10-208.20

**HOHLMEISSEL- UND KNOCHENSPLITTERZANGEN
BON RONGEURS — BONE CUTTING FORCEPS**



Ruskin
18 cm, 7"
10-104.04 - 10-106.07



gerade/straight



gebogen/curved

4 mm	10-106.04	10-104.04
5 mm	10-106.05	10-104.05
6 mm	10-106.06	10-104.06
7 mm	10-106.07	10-104.07



Ruskin
23 cm, 9"
10-108.05 - 10-108.07



5 mm 10-108.05
6 mm 10-108.06
7 mm 10-108.07



Smith-Petersen
24 cm, 9 1/2"
10-131.24 - 10-133.24



10-131.24
gerade
straight



10-132.24
gebogen
curved



10-133.24
stark gebogen
full curved

**HOHLMEISSEL- UND KNOCHENSPLITTERZANGEN
BON RONGEURS — BONE CUTTING FORCEPS**



$\frac{1}{2}$
Stille Ruskin
23 cm, 9"
10-114.23



$\frac{1}{2}$
Frykholm
24 cm, 9 $\frac{1}{2}$ "
10-220.24



$\frac{1}{2}$
Stille Luer
10-112.22 - 10-113.26

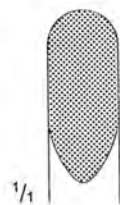

gerade
straight

Ges. Länge total length
22 cm
8 $\frac{1}{2}$ "

Ges. Länge total length
26 cm
10 $\frac{1}{2}$ "



gebogen
curved

10-112.22

10-112.26

**HOHLMEISSEL- UND KNOCHENSPLITTERZANGEN
BON RONGEURS — BONE CUTTING FORCEPS**



$\frac{1}{2}$
Echlin
23 cm, 9"
10-115.23 - 10-117.23



2 x 10 mm
10-115.23



3 x 10 mm
10-116.23



4 x 10 mm
10-117.23



$\frac{1}{2}$
Stille
23 cm, 9"
10-111.05 - 10-111.06



Maulbreite/Bite:

5 x 14 mm
10-111.05

6 x 14 mm
10-111.06



$\frac{1}{2}$
Semb
22,5 cm, 9"
10-118.23

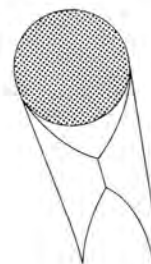

**HOHLMEISSEL- UND KNOCHENSPLITZERZANGEN
BON RONGEURS — BONE CUTTING FORCEPS**

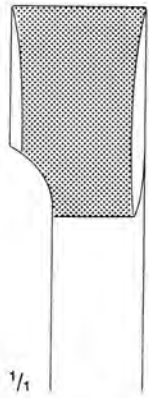

1/1

Sauerbruch
10-120.31

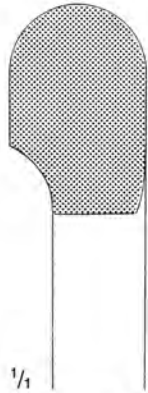

1/1

Sauerbruch
10-119.31

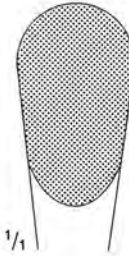

1/1

Gesamt-Länge
total length

22 cm
27 cm

gerade/straight

10-113.23
10-113.27



1/1

gebogen/curved

10-112.23
10-112.27



1/2

Sauerbruch
31 cm, 12³/₈"



1/2

Stille Luer
10-112.23 - 10-113.27

**HOHLMEISSEL- UND KNOCHENSPLITTERZANGEN
BON RONGEURS — BONE CUTTING FORCEPS**



Leksell-Stille
24 cm, 9 1/2"
10-110.03 - 10-110.08

Maulbreite/Bite:
3 x 16
4 x 16
5 x 16
6 x 16
7 x 16
8 x 16

Art.-Nr.
10-110.03
10-110.04
10-110.05
10-110.06
10-110.07
10-110.08

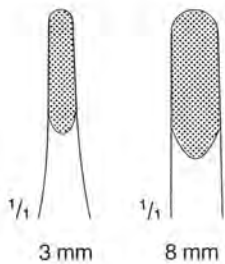
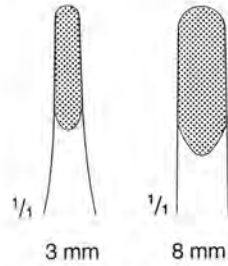

Maulbreite/Bite:
3 x 16
4 x 16
5 x 16
6 x 16
7 x 16
8 x 16

Art.-Nr.
10-210.03
10-210.04
10-210.05
10-210.06
10-210.07
10-210.08



Leksell, stark gebogen –
Leksell, full curved
24 cm, 9 1/2"
10-210.03 - 10-210.08

**HOHLMEISSEL- UND KNOCHENSPLITTERZANGEN
BON RONGEURS — BONE CUTTING FORCEPS**



Dale
34 cm / 13 1/3"
10-156.03



Syper
36 cm / 14 3/8"

Maulbreite / Bite:	Art.-Nr.
4 mm	10-145.04
5 mm	10-145.05
8 mm	10-145.08
12 mm	10-145.12

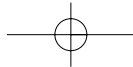

**HOHLMEISSEL- UND KNOCHENSPLITTERZANGEN
BON RONGEURS — BONE CUTTING FORCEPS**

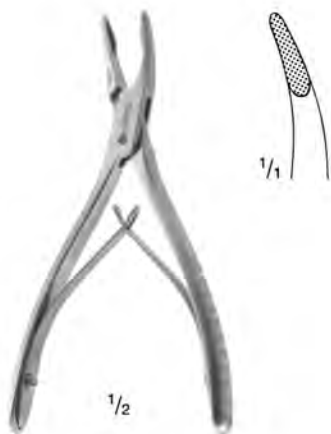

Mini-Friedmann
12 cm, 5"
10-140.12

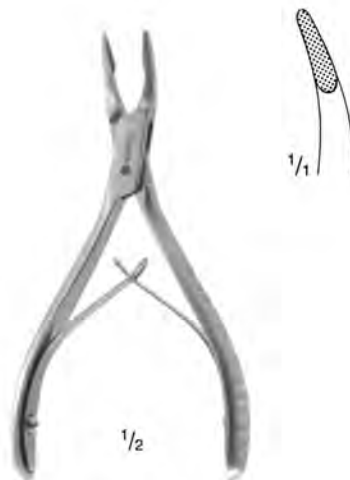

Friedmann
14 cm, 5 $\frac{1}{2}$ "
10-144.14

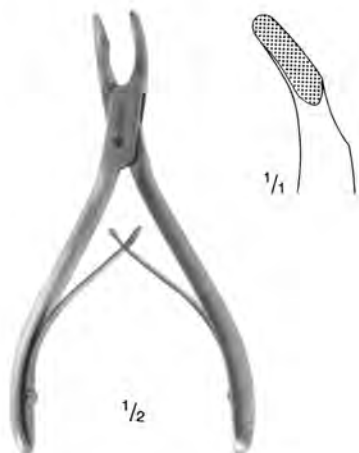

Cleveland
14 cm, 5 $\frac{1}{2}$ "
10-148.14

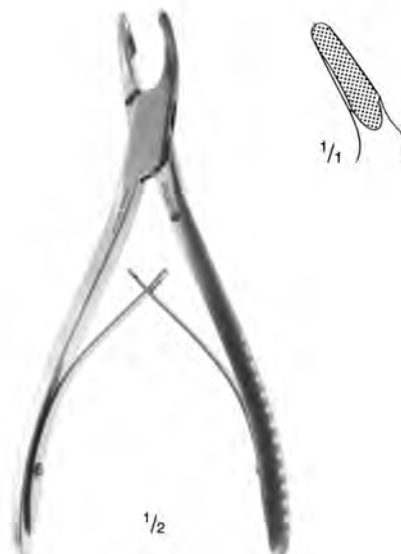

Cleveland
17 cm, 6 $\frac{3}{4}$ "
10-152.17

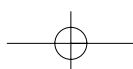

**HOHLMEISSEL- UND KNOCHENSPLITTERZANGEN
BON RONGEURS — BONE CUTTING FORCEPS**

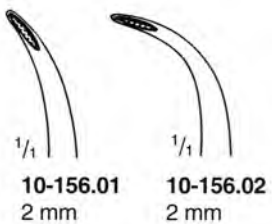

10-156.01
2 mm

10-156.02
2 mm

1/2

Stellbrink
17 cm, 6 3/4"
10-156.01 - 10-156.02

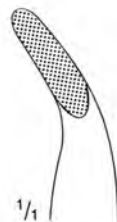
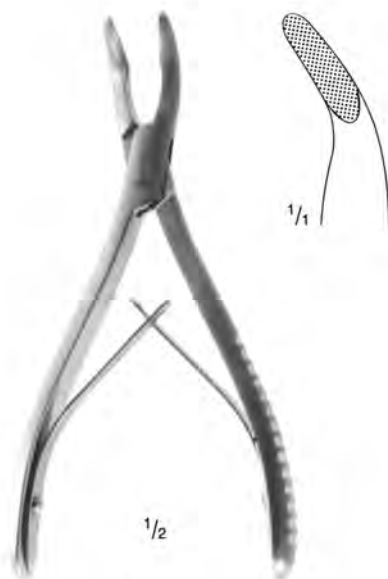

1/1

1/2

Mead
16,5 cm, 6 1/2"
10-160.16

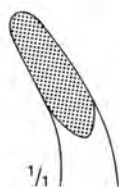

1/1

1/2

Hartmann
18,5 cm, 7 1/4"
10-134.18

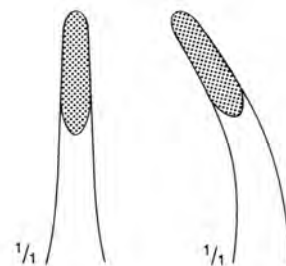

1/1

1/1

10-128.18

10-129.18

1/2

Jansen
18 cm, 7"
10-128.18 - 10-129.18

**HOHLMEISSEL- UND KNOCHENSPLITTERZANGEN
BON RONGEURS — BONE CUTTING FORCEPS**



Luer
17 cm, 6 3/4"
10-122.17 - 10-123.17

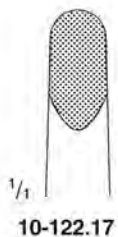

Blumenthal
15 cm, 6"
10-172.15 - 10-180.15

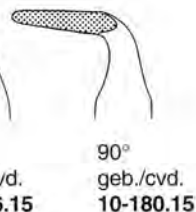

Luer
15 cm, 6"
10-184.15 - 10-192.15

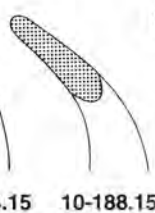

**HOHLMEISSEL- UND KNOCHENSPLITTERZANGEN
BON RONGEURS — BONE CUTTING FORCEPS**



Lempert
19 cm, 7 1/2"
10-124.19 - 10-125.19



10-124.19



10-125.19



Lempert
16 cm, 6 1/2"
10-126.16 - 10-127.16



10-126.16



10-127.16

**HOHLMEISSEL- UND KNOCHENSPLITTERZANGEN
BON RONGEURS — BONE CUTTING FORCEPS**

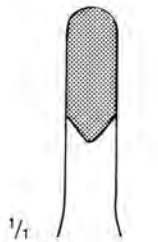

1/1
Adson
gerade/straight

10-135.20 Maulbreite/Bite:
10-137.20 8 x 16
7 x 16

Adson
20 cm, 8"
10-135.20 - 10-138.20



1/1
Adson
gebogen/curved

10-136.20 Maulbreite/Bite:
10-138.20 8 x 16
7 x 16

Adson mit Zähne/toothed
20 cm, 8"
20-221.20



Beyer
180 mm, 7"
10-130.18

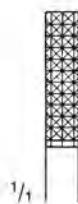

1/1



20-220.00
Slip-on guard



Rubin
Septum Quetschzange
Septal Morselizer 8"
210 mm
gerade/straight
20-219.21
gebogen/curved
20-220.21

**HOHLMEISSEL- UND KNOCHENSPLITTERZANGEN
BON RONGEURS — BONE CUTTING FORCEPS**



1/2

Liston
20-100.14 - 20-110.22

	gerade straight	gebogen curved
14 cm 5 1/2"	20-100.14	20-110.14
17 cm 6 3/4"	20-100.17	20-110.17
19 cm 7 1/2"	20-100.19	20-110.19
22 cm 8 3/4"	20-100.22	20-110.22



1/2

Cottle Kazanjian
19 cm, 7 1/2"
20-150.19



1/1



1/2

Littauer
15 cm, 6"
20-152.15

**HOHLMEISSEL- UND KNOCHENSPLITTERZANGEN
BON RONGEURS — BONE CUTTING FORCEPS**

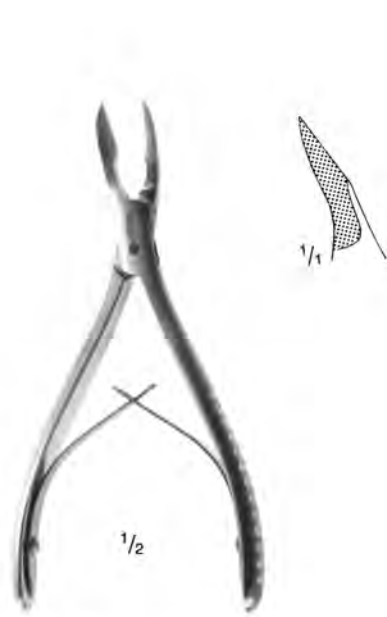

Cleveland
15 cm, 6"
20-158.15



Cleveland
17 cm, 6 3/4"
20-154.17



Böhler, gerade/straight
15 cm, 5 3/4"
20-200.15 - 20-201.15



Böhler, gebogen/curved
15 cm, 5 3/4"
20-201.15

**HOHLMEISSEL- UND KNOCHENSPLITTERZANGEN
BON RONGEURS — BONE CUTTING FORCEPS**



McIndoe
17,5 cm, 7"
20-203.18



1/1



Ruskin-Liston
18,5 cm, 7 1/4"
20-204.18 - 20-205.18



1/1

20-204.18



1/1

20-205.18



1/1

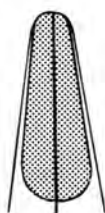

20-214.17

1/1

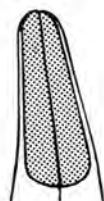

20-215.17

Ruskin-Rowland
17 cm, 6 3/4"
20-214.17 - 20-215.17

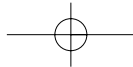

**HOHLMEISSEL- UND KNOCHENSPLITTERZANGEN
BON RONGEURS — BONE CUTTING FORCEPS**



Stille-Liston
Länge/
length
23 cm
27 cm



gerade/
straight
20-206.23
20-206.27

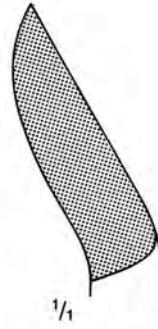

gebogen/
curved
20-207.23
20-207.27



Stille-Liston
27 cm, 10 1/2"
20-208.26

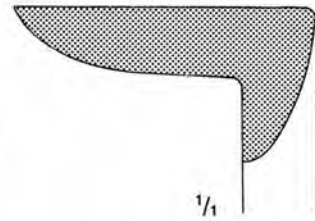

1/1

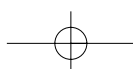

**HOHLMEISSEL- UND KNOCHENSPLITTERZANGEN
BON RONGEURS — BONE CUTTING FORCEPS**



Liston-Key
27 cm, 10¹/₂"
20-209.27



Semb
24 cm, 9¹/₂"
20-210.25

FLACHZANGEN - FLAT NOSE PLIERS
FLACHZANGEN OHNE HARTMETALL - FLAT NOSE PLIERS



30-105.05



30-105.07

30-105.05 - 30-105.07
18 cm, 7"

Flachzangen mit Hartmetall – Flat Nose Pliers with TC-inserts



30-102.01



30-102.03



30-102.05



30-102.06

30-102.01 - 30-102.06
18 cm, 7"

**DRAHT- UND BOLZENSCHNEIDER
WIRE CUTTING — PLIES-PIN CUTTER**



30-100.18
TC-Drahtschneidezange
TC-Wire Cutting Pliers
18 cm

für weichen Draht bis 2,0 mm
for soft wire up to 2,0 mm

für harten Draht bis 1,7 mm
for hard wire up to 1,7 mm

30-101.22
TC-Drahtschneidezange
TC-Wire Cutting Pliers
22 cm

für weichen Draht bis 3,0 mm
for soft wire up to 3,0 mm

für harten Draht bis 2,5 mm
for hard wire up to 2,5 mm



30-103.18
TC-Kopf und Seitenschneider
TC-Side and End Cutter
18 cm

für harten Draht bis 1,7 mm
for hard wire up to 1,7 mm

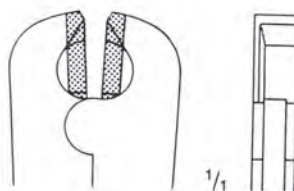

**DRAHT- UND BOLZENSCHNEIDER
WIRE CUTTING — PLIES-PIN CUTTER**

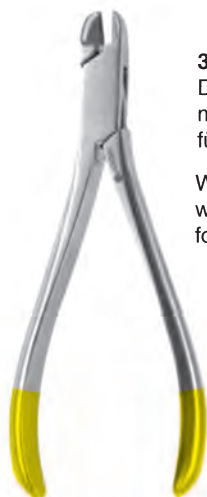

30-119.14
Drahtschneidezange 14 cm
mit Hartmetall
für harten Draht bis 0,6 mm Ø

Wire cutting pliers 14 cm
with Tungsten Carbide
for hard wire up to 0,6 mm diam.

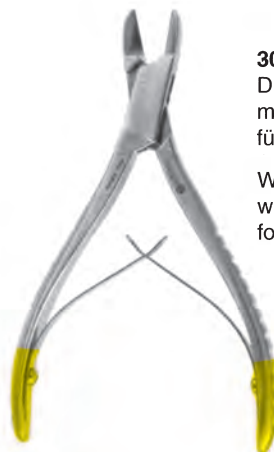

30-118.12
Drahtschneidezange 12,5 cm
mit Hartmetall
für harten Draht bis 0,6 mm Ø

Wire cutting pliers 12,5 cm
with Tungsten Carbide
for hard wire up to 0,6 mm diam.



30-121.18
Platten- und Drahtschneidezange
18 cm, mit Hartmetall,
bis 1,7 mm Ø

Plate- and wire cutting pliers
18 cm, with Tungsten Carbide
up to 1,7 mm diam.

**DRAHT- UND BOLZENSCHNEIDER
WIRE CUTTING — PLIES-PIN CUTTER**



30-110.38 38 cm

Bolzenschneider zum Abwickeln von
Drähten, Schrauben und Nägeln bis zu 4,5 mm Ø

Cutter for cutting off wires, bolts, pins, up to 4.5 mm diam.

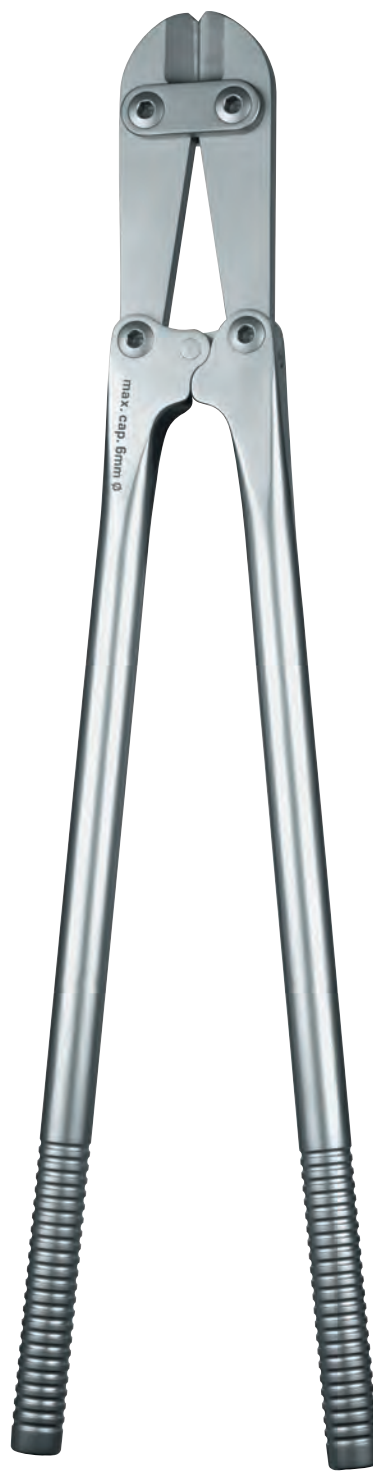

30-110.50 47 cm

30-110.60 54 cm

Bolzenschneider zum Abwickeln von
Drähten, Schrauben und Nägeln bis zu 6 mm Ø

Cutter for cutting off wires, bolts, pins, up to 6 mm diam.

**DRAHT- UND BOLZENSCHNEIDER
WIRE CUTTING — PLIES-PIN CUTTER**



1/2

30-110.24
24 cm / 8 1/2"



1/2

30-090.18
18 cm / 7 1/4"

Er schneidet mühelos:
Drähte von 2 mm - 3,5 mm Durchmesser
Platten von 2 mm Stärke.

Cutting easily:
Wires from 2 mm to 3.5 mm diameter
Plates with 2 mm thickness.



**HOHLMEISSEL- UND KNOCHENSPLITTERZANGEN
BON RONGEURS — BONE CUTTING FORCEPS**